

TECHNOLOGY AND APPLIED R&D NEEDS FOR

Molten Salt Chemistry

Innovative Approaches to Accelerate
Molten Salt Reactor Development and Deployment

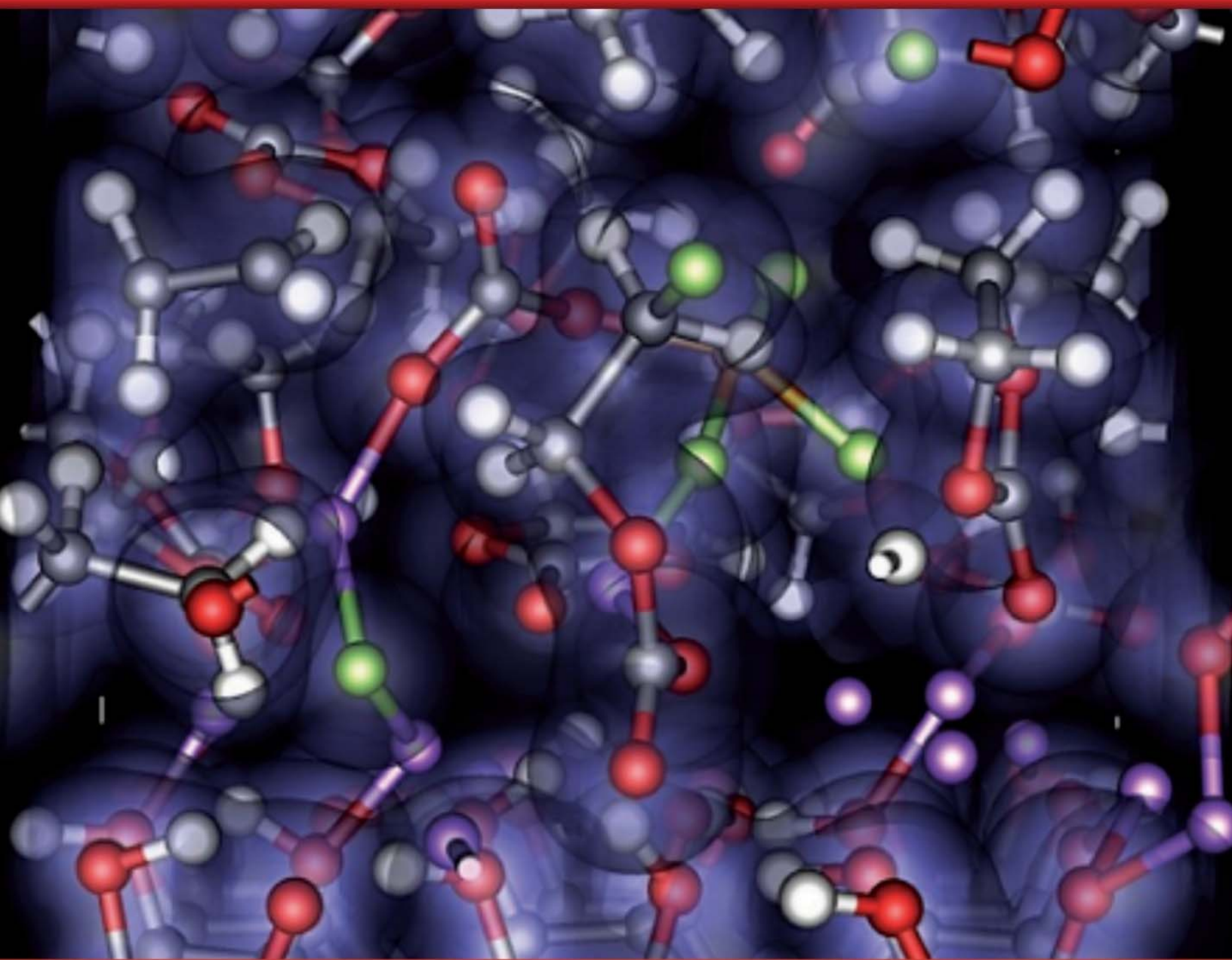

The cover depicts the chemical and physical complexity of the various species and interfaces within a molten salt reactor. To advance new approaches to molten salt technology development, it is necessary to understand and predict the chemical and physical properties of molten salts under extreme environments; understand their ability to coordinate fissile materials, fertile materials, and fission products; and understand their interfacial reactions with the reactor materials. Modern x-ray and neutron scattering tools and spectroscopy and electrochemical methods can be coupled with advanced computational modeling tools using high performance computing to provide new insights and predictive understanding of the structure, dynamics, and properties of molten salts over a broad range of length and time scales needed for phenomenological understanding. The actual image is a snapshot from an ab initio molecular dynamics simulation of graphene-organic electrolyte interactions. Image courtesy of Bobby G. Sumpter of ORNL.

Report for the US Department of Energy, Office of Nuclear Energy Workshop

Molten Salt Chemistry Workshop

Technology and Applied R&D Needs for Molten Salt Chemistry

April 10–12, 2017

Oak Ridge National Laboratory

Co-chairs:

David F. Williams, Oak Ridge National Laboratory

Phillip F. Britt, Oak Ridge National Laboratory

Working Group Co-chairs

Working Group 1: Physical Chemistry and Salt Properties

Alexa Navrotsky, University of California–Davis

Mark Williamson, Argonne National Laboratory

Working Group 2: Analytical Chemistry

Sam Bryan, Pacific Northwest National Laboratory

Sheng Dai, Oak Ridge National Laboratory

Working Group 3: Molten Salt Fission Product Chemistry and Solid Salt Radiolysis

Bill DeCul, Oak Ridge National Laboratory

Tina Nenoff, Sandia National Laboratories

Working Group 4: Materials Compatibility

James Keiser, Oak Ridge National Laboratory

Preet Singh, Georgia Institute of Technology

Working Group 5: Computational Chemistry and Materials Science

Bobby Sumpter, Oak Ridge National Laboratory

Brian Wirth, University of Tennessee–Knoxville

Charles Henager, Pacific Northwest National Laboratory

Office of Nuclear Energy Leads

John Herczeg, Deputy Assistant Secretary for Nuclear Technology Research and Development, DOE-NE

Stephen Kung, Program Manager, DOE-NE

ORNL Creative Services and ORNL Research Library

Deborah Counce, LeJean Hardin, Cindy Johnson, Kathy Jones, James Kidder



Table of Contents

Abbreviations, Acronyms, and Initialisms	v
Executive Summary	vii
1. Introduction.....	1
1.1 Workshop Organization	3
1.2 Future Research Directions	3
References	4
2. FRD 1: Understanding, Predicting, and Optimizing the Physical Properties of Molten Salts	5
2.1 Background and Current Status.....	5
2.2 Technical Challenges and Research Directions	7
2.2.1 Determining the Physical Properties of Molten Salts	7
2.2.2 Predicting the Chemical Speciation, Structure, and Dynamics of Molten Salts Solutions	15
References	19
3. FRD 2: Understanding the Structure, Dynamics, and Chemical Properties of Molten Salts	23
3.1 Background and Current Status.....	23
3.2 Technical Challenges and Research Directions	28
3.2.1 Determining Molecular Structure by X-ray and Neutron Scattering and Spectroscopy	28
3.2.2 Correlating Electrochemistry and Spectroscopy for Online Monitoring and Predictive Modeling	30
References	33
4. FRD 3: Understanding Fission and Activation Product Chemistry and Radiation Chemistry	37
4.1 Background and Current Status.....	37
4.2 Technical Challenges and Research Directions	38
4.2.1 Understanding the Physical, Chemical, and Radiochemical Properties of the Fission and Activation Products in Molten Salts.....	38
4.2.2 Correlating Fission and Activation Product Behavior with Surrogates	40
4.2.3 Understanding the Physical and Chemical Impact of Short-lived Isotopes	42
References	43
5. FRD 4: Understanding Materials Compatibility and Interfacial Phenomena	45
5.1 Background and Current Status.....	45
5.2 Technical Challenges and Research Directions	46
5.2.1 Advancing Spectroscopic and Scattering Investigation of MSR Interfaces.....	46

5.2.2	Understanding Materials Compatibility in the Molten Salts Reactor Environment	47
5.2.3	Understanding Degradation Processes at the Material–Salt Interface	50
5.2.4	Understanding the Combined Effect of Chemistry and Radiation at the Interface.....	51
5.2.5	Predicting Interfacial Interactions between Molten Salts and Structural Materials and/or Gases	53
	References	56
6.	FRD 5: Guiding Next-Generation Materials for Molten Salt Reactors	59
6.1	Background and Current Status.....	59
6.2	Technical Challenges and Research Directions	59
6.2.1	Enabling Rapid Deployment of MSR Materials: Computational Challenges.....	59
6.2.2	Guiding Experimental Exploration of Advanced “Super” Materials.....	63
6.2.3	Advancing Code Qualification of New Materials.....	64
	References	66
7.	FRD 6: Creating a Virtual Reactor Simulation	67
7.1	Background and Current Status.....	67
7.2	Technical Challenge and Research Directions	67
7.2.1	Creating a Virtual Reactor Simulation.....	67
	References	70
	APPENDIX A: WORKSHOP RESOURCE DOCUMENT	A-1
	APPENDIX B: A DEVELOPER’S PERSPECTIVE ON THE NECESSITY OF SALT PROPERTY RESEARCH	B-1
	APPENDIX C: WORKSHOP AGENDA	C-1
	APPENDIX D: WORKSHOP PARTICIPANTS.....	D-1

Abbreviations, Acronyms, and Initialisms

AIMD	ab initio molecular dynamics
ARE	Aircraft Reactor Experiment
CALPHAD	Computer Coupling of Phase Diagrams and Thermochemistry
CMD	classical molecular dynamics
DFT	density functional theory
DOE	Department of Energy
DSC	differential scanning calorimetry or differential scanning calorimeter
EMF	electromotive force
EXAFS	extended XAFS
FLiBe	${}^7\text{Li}_2\text{BeF}_4$
FRD	Future Research Direction
GAIN	Gateway for Acceleration of Innovation in Nuclear
GI-XAFS	grazing incidence x-ray absorption fine structure spectroscopy
IR	infrared
JICS	Joint Institute for Computational Sciences
MAS	magic-angle spinning
MD	molecular dynamics
MOF	metal-organic framework
MSBR	Molten Salt Breeder Reactor
MSR	molten salt reactor
MSRE	Molten Salt Reactor Experiment
NE	Office of Nuclear Energy
NMR	nuclear magnetic resonance
ORNL	Oak Ridge National Laboratory
PDF	pair distribution function

QM/MD	quantum mechanics molecular dynamics
R&D	research and development
SEMO	semi-empirical molecular orbital theory
TB-DFT	tight binding DFT
TGA	thermogravimetric analysis
UV-vis	ultraviolet-visible
UV-vis-IR	ultraviolet-visible-infrared
VR	virtual reactor
VUQ	validation and uncertainty quantification
WG	working group
XAFS	x-ray absorption fine structure spectroscopy
XAS	x-ray absorption spectroscopy
XRD	x-ray diffraction

Executive Summary

At the dawn of this century, nuclear experts in the Generation IV International Forum recognized the unique capabilities of molten salts in one of six next-generation reactor designs. Since that time, various national research and development programs, most notably in China, have focused resources on developing molten salt reactors (MSRs) of various designs. In the past decade in the United States, new designs and applications have matured to the point that a number of companies have dedicated resources, enthusiasm, and new approaches to MSR technology development. The US Department of Energy (DOE) and its national laboratories have supported this evolution by working with multiple companies and universities; this relationship matured in 2015 with the creation of the Gateway for Acceleration of Innovation in Nuclear (GAIN) initiative working in concert with the US Industry MSR Technical Working Group.

In response to the sustained resurgence of the MSR concept, the DOE Office of Nuclear Energy organized the Molten Salt Chemistry Workshop at Oak Ridge National Laboratory on April 10–12, 2017, for the purpose of identifying innovative science-based, technology driven approaches to accelerate MSR development and deployment. In the United States and across the world, the MSR concept is recognized as one of the few game-changing technologies that can overcome existing barriers to the adoption of commercial nuclear power. Not only is the generation of electricity within a once-through uranium fuel cycle foreseen; in addition, proponents of MSR technology envision completely new opportunities to rationalize fuel cycles by securely using a variety of fissile and fertile resources to supply high-temperature, low-pressure industrial heat and to create a cost-competitive, safe, and more sustainable commercial nuclear option.

This workshop was rooted in a multidisciplinary dialogue among a wide range of experts spanning chemistry, materials science, nuclear science, and engineering from academia, national laboratories, the US government, and commercial organizations. There was strong participation from the US Industry Technical Working Group, as well as participation from small and large companies with specific interests and expertise in molten salt technology. Since MSR technology has a chemical focus and chemical challenges, the participants were focused toward the chemical sciences—but a very strong contingent of materials, computational, and nuclear scientists/engineers also participated. These experts were organized into five working groups: (1) physical chemistry and salt properties, (2) analytical chemistry, (3) molten salt fission product chemistry and solid-state radiolysis, (4) materials compatibility, and (5) computational science and material science. The Introduction section of this document and the appendices provide details on how the workshop was conducted and who participated.

Fourteen R&D topics identified during the workshop were integrated into 6 Future Research Directions (FRDs) after the workshop. The input for and definition of each FRD contained contributions from multiple working groups and represent a collective effort from the workshop participants.

The 21st century MSR mission is distinctly different from the original thermal-spectrum molten salt breeder reactor, and the next generation of MSR salts will be different. Thus a deeper understanding is needed of molten salt physical and chemical properties to optimize the salt composition for new applications. Choosing the right salt composition requires a knowledge of the salt's capacity to dissolve fissile, fertile, and particular fission products and of the physical properties of the salt. Phase diagrams and thermophysical properties of molten salts are needed in the early stages of development to justify the design and to define the safety boundaries. The *first FRD* (Understanding, Predicting, and Optimizing the Physical Properties of Molten Salts) highlights the need to apply modern measurement techniques and modeling and simulation tools to accelerate the design, discovery, and characterization of salts optimized for various types of MSRs. Purification, characterization, and handling procedures for molten salts—as well as analytical standards for pedigree molten salts—need to be accessible to the scientific community to ensure the field can rapidly process and share reliable data.

The structure and dynamics of molten salts play a key role in understanding phase transitions, viscosity, thermal conductivity, volatility, solubility of fission products, and corrosion. Identifying and understanding the structure, properties, and reactivity of these complex salt species is dependent upon coordination chemistry, the redox state and Lewis-acidity of the system. Doing so requires a combination of advanced measurement tools to identify the structures, and modeling capabilities to understand and interpret the structure, dynamics, and properties. The **second FRD** (Understanding the Structure, Dynamics, and Chemical Properties of Molten Salts) highlights how modern x-ray and neutron scattering and spectroscopic tools (which were not available during the studies in the 1960s and 1970s) and electrochemical methods can be coupled with advanced modeling capabilities to provide new insights into the structure, dynamics, and properties of salt species on the length and time scales needed for phenomenological understanding. This capability is needed for advancement in all other FRDs.

The **third FRD** (Understanding Fission and Activation Product Chemistry and Radiation Chemistry) highlights the need to understand the rapid decay and chemical transmutation of fission and activation products and the unique phenomena related to radiation-induced chemistry. It is essential to understand which fission products are soluble, insoluble, partially soluble, and volatile, and how fission products change the corrosivity of the melt. Highly specialized approaches are needed to address the fate of insoluble fission products that evolve through complex decay chains, as well as specific radiation effects on chemical species.

The **fourth FRD** (Understanding Materials Compatibility and Interfacial Phenomena) addresses the need to fundamentally understand material degradation (such as corrosion) and interfacial reactions (including the combined chemical and radiation effect) to develop new, more stable materials for MSR. This requires specialized experimental approaches (including a flow loop), instrumentation, and analysis to study interfacial reactions—for both out-of-pile and in-pile measurements—to follow trace levels of dissolved and dispersed species in solution and concentrations of surface species and surface morphology. Computational modeling is needed to gain a molecular-level understanding of the chemical reactivity of molten salts to provide insights into mitigating corrosion, fission product off-gassing, gas entrainment, and materials precipitation.

The **fifth FRD** (Guiding Next-Generation Materials for Molten Salt Reactors) addresses the need to develop the next generation of materials that will enable MSR developers to reach the reactor performance targets. Structural materials proposed for MSR must endure extreme environments, including high fluences of neutrons, high operating temperatures, and corrosive environments. New approaches are needed to develop superior alloys and composites that are optimized for MSR which build off detailed physical, chemical, and materials studies and combine modern experimental approaches—including high throughput screening—with state-of-the-art computational materials science approaches. Advances in computational modeling can help guide materials development through an understanding of chemomechanical degradation mechanisms, radiation damage, and thermomechanical degradation of microstructure and property evolution. Timelines for materials development, testing, and qualification must be accelerated to incorporate new materials into MSR designs through innovative approaches using modern analytical and computational tools with new testing protocols.

The **sixth FRD** (Creating a Virtual Reactor Simulation) focuses on developing the modeling and simulation tools necessary to understand the behavior of the reactor throughout its lifetime and provide dynamic reactor and irradiation capsule emulation for chemical and isotopic source terms. To accurately predict MSR conditions—including neutron transport, thermal hydraulics, isotopic transmutation, thermochemical properties of the fuel salt, and corrosion effects—a virtual reactor simulator needs to be developed which builds off the experimental and computational advances made in the previous FRD and incorporates a new understanding of the physical, chemical, and radiochemical phenomena found in MSRs. This simulation tool will not only allow understanding of the operational issues but also allow analysis of the fuel cycle, prediction of waste forms and quantities, and assessment of new reactor concepts, salts, and chemistries.

1. Introduction

Since 1948, scientists have sought the creation of a new type of high-temperature fluid-fueled nuclear reactor that is not constrained by the limitations of solid fuels and conventional coolants. The molten salt reactor (MSR) emerged as the only viable concept for this class of reactor. In 1954, scientists at Oak Ridge National Laboratory (ORNL) demonstrated the short-duration but very-high-temperature capabilities of a molten-fluoride-fueled reactor in the Aircraft Reactor Experiment (ARE) [1]. The fuel salt was a mixture of $\text{NaF-ZrF}_4\text{-UF}_4$, and the moderator was BeO . The reactor operated successfully for 9 days at an outlet temperature of $860\text{ }^\circ\text{C}$ and power up to 2.5 MW_t . At the end of the Aircraft Nuclear Propulsion program, molten salt technology was repurposed with the objective of developing a thermal spectrum breeder reactor based upon the thorium fuel cycle. From 1965 through 1969, ORNL operated the 8 MW Molten Salt Reactor Experiment (MSRE), which demonstrated many of the key technologies needed to justify the pursuit of a commercial MSR. The MSRE fuel salt consisted of ${}^7\text{LiF-BeF}_2\text{-ZrF}_4\text{-UF}_4$ and it flowed through a graphite moderator at atmospheric pressure at approximately $650\text{ }^\circ\text{C}$. (${}^7\text{Li}$ was used to prevent the undesired production of tritium from ${}^6\text{Li}$ by neutron-induced fission.) The operation demonstrated the use of both ${}^{235}\text{U}$ and ${}^{233}\text{U}$ as the fissile driver in the fuel salt, as well as minor refueling adjustments with ${}^{239}\text{Pu}$. The coolant salt in the secondary loop was ${}^7\text{Li}_2\text{BeF}_4$ (FLiBe). Experience with these test reactors and the associated research and development (R&D) showed the MSR concept was viable; but it also highlighted the challenges that remained in the domains of salt chemistry, fission product chemistry, materials and corrosion chemistry, radiation chemistry, analytical chemistry, and fuel processing. Figure 1 charts the evolution of MSR concepts.

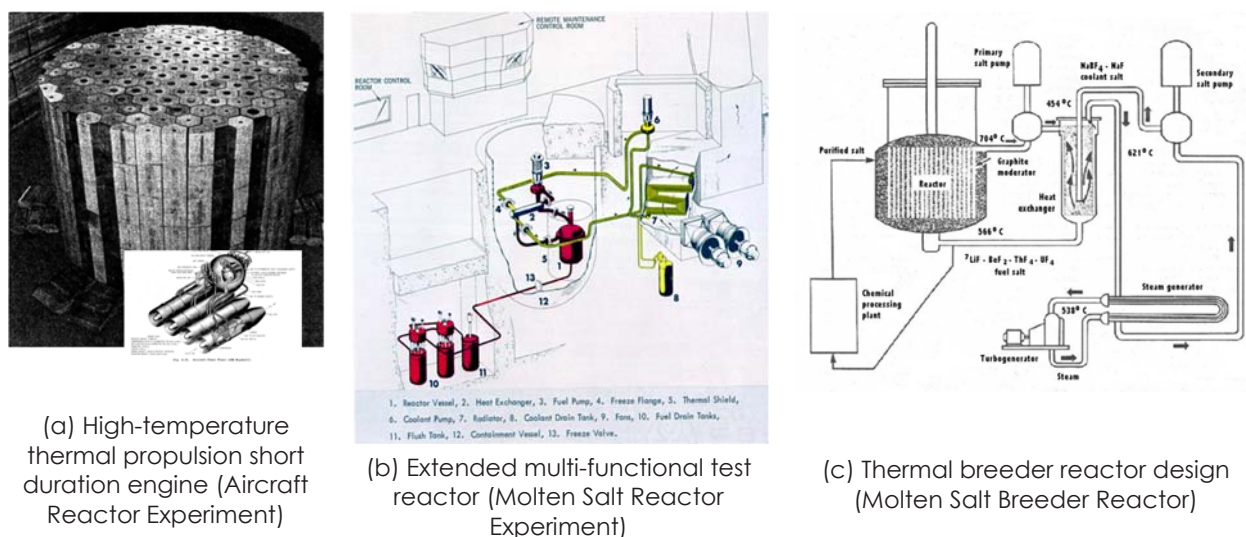

Figure 1. The 20th century evolution of the molten salt reactor concept. | Images courtesy of Oak Ridge National Laboratory

With the cessation of the US commitment to thorium-breeder reactor designs in 1976, a different focus eventually took hold for the MSR concept. It is now envisioned as a new way to rationalize the overall fuel cycle without conventional aqueous reprocessing, with novel fueling and refueling schemes that do not entail remote solid-fuel refabrication from recycled actinides; and as a potential pathway to safer, more economical nuclear electricity generation and supply of high-temperature, low-pressure industrial heat. This vision was recognized in the international commitment to the MSR concept within the Generation Four International Forum. Strong efforts in MSR development are sustained in many European and Asian countries (especially China) (see [World Nuclear Association](#)). Most of the interest in

the US private sector revolves around the use of low-enrichment, high-actinide-content fuel salts, but a wide variety of concepts are being considered using fluoride and chloride salts (see Appendix A). MSRs under consideration today are either solid-fueled salt-cooled designs or liquid-salt-fueled designs, as shown in Figure 2. Solid-fueled salt-cooled reactors contain solid ceramic fuel in prisms, plates, or pebbles. Molten salt coolants flow over the solid fuel, and the heat is removed in the primary heat exchanger by a secondary coolant; it transports the heat to a power generating system, such as a gas or steam turbine. Molten salts have excellent heat transfer properties that rival those of water and permit them to operate at much higher temperatures than light water reactors and at near-atmospheric pressures in the primary loop.

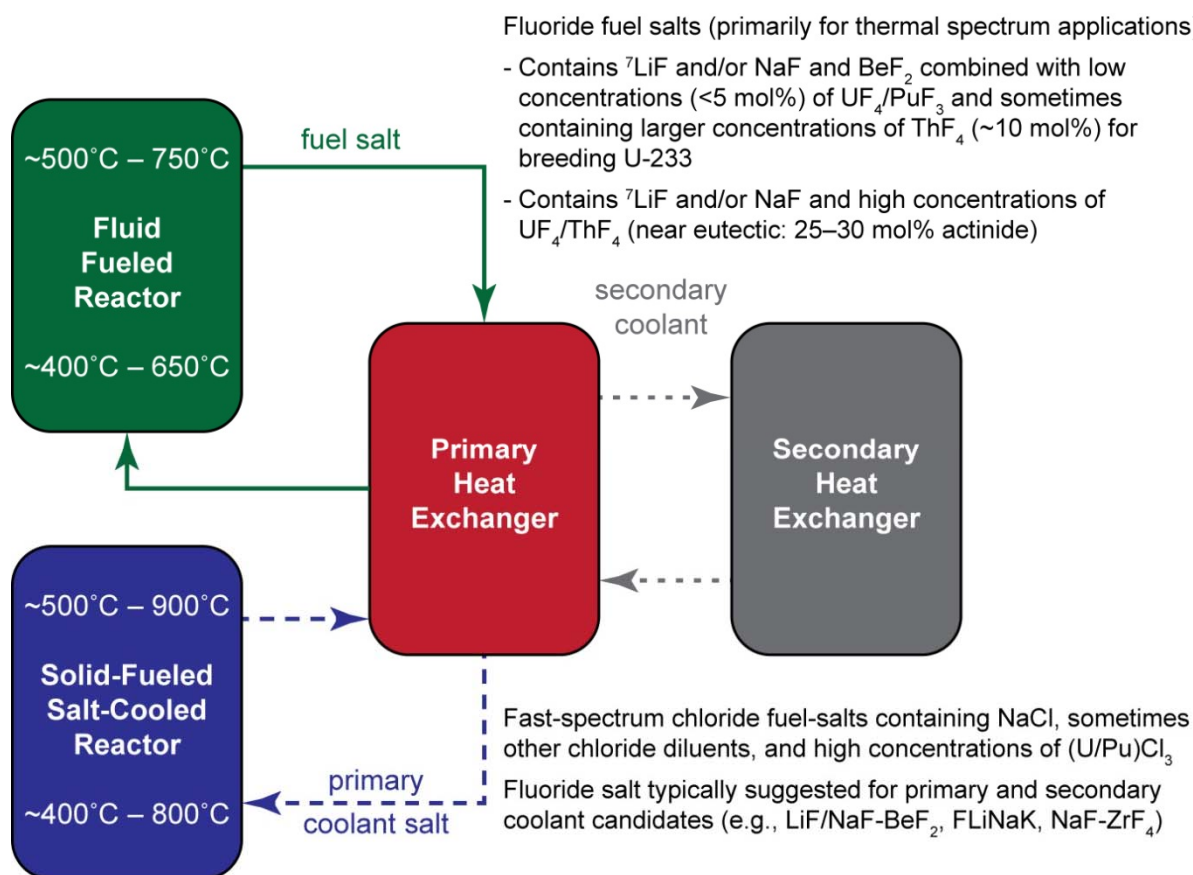

Figure 2. In an MSR, the choice of salt determines the mission of the reactor. It imparts versatility for multiple applications such as electricity production, generation of process heat, or burnup of actinide waste (see Appendix A). | Image courtesy of Oak Ridge National Laboratory

Liquid-salt-fueled reactors—as demonstrated during the operation of the ARE and MSRE and envisioned in the Molten Salt Breeder Reactor (MSBR) design—contain all fissile and fertile constituents (and many fission products) dissolved within a homogeneous fluid fuel that circulates in the primary loop. The vast majority of fission energy is deposited uniformly throughout the fluid fuel, which serves as both fuel matrix and primary coolant. Heat is shuttled to the balance-of-plant by a nonradioactive low-pressure secondary molten salt via two heat exchangers (Figure 2). Fluid-fueled-reactors have the significant virtue that they do not require solid fuel fabrication/refabrication/qualification; but they impose the requirement to control and manage all of the fission products that are released into the primary loop as either dissolved, insoluble, or gaseous species.

As interest continues to grow in MSRs, new applications involve new materials and chemistry requirements. Although some R&D requirements for salt chemistry and materials are the same as those remaining at the end of the MSBR development program in 1976 (e.g., see Engel et al. 1979 [2]), other requirements are driven by the use of new salts (e.g., chlorides), the realization of new conditions, and the pursuit of new application domains. To advance the potential viability of MSRs, additional fundamental and applied R&D is needed for salt chemistry, fission product chemistry, materials and corrosion chemistry, radiation chemistry, analytical chemistry, and fuel processing.

1.1 Workshop Organization

In recognition of the renewed commercial interest in MSRs, the US Department of Energy (DOE) Office of Nuclear Energy (NE), in coordination with MSR developers, plans to reestablish core competencies and R&D capabilities in molten salt chemistry at DOE national laboratories and US universities. This effort will provide a technical basis for supporting the goal of US industries to commercialize MSR technologies and will support the MSR research community in training a broad base of next-generation expertise.

To identify potential innovative science-based, technology-driven approaches to accelerate the deployment of MSR technologies, and to engage the broader scientific community to advance the knowledge and technology base of molten salt chemistry, DOE sponsored a 3 day workshop, *Technology and Applied R&D Needs for Molten Salt Chemistry*. It was held at ORNL on April 10–12, 2017. In addition to molten salt experts, the workshop included experts in traditional disciplines of chemistry (physical, analytical, fission product, and materials chemistry) and nontraditional disciplines (computational chemistry and materials science) from national laboratories, universities, and industry. A total of 72 experts attended the workshop—15 from universities, 35 from national laboratories, 15 from industry, and 7 from government agencies. (Appendix B is list of the workshop participants.)

In preparation for the meeting, a Resource Document (Appendix A) was drafted to orient and educate all participants on the scientific and technology advances underpinning MSR technologies. Emphasis was placed on identifying fundamental knowledge gaps. The agenda of the workshop is provided in Appendix C. The workshop began with a half-day plenary session of invited experts from DOE, industry, universities, and national laboratories to help define where the science and technology stands currently and where it needs to go. Following the plenary session, the workshop participants separated into five working groups: Physical Chemistry and Salt Properties, Analytical Chemistry, Molten Salt Fission Product Chemistry and Solid Salt Radiolysis, Materials Compatibility, and Computational Chemistry and Materials Science. The panels were charged with identifying (1) research topics that address both short-term technology barriers and long-term (5–10 years) grand challenges that might enable revolutionary changes in MSR technology and (2) a set of Future Research Directions (FRDs) that might accelerate MSR technology development and deployment. At the midpoint of the workshop, each group reported to all of the workshop participants on its progress toward identifying FRDs. The FRDs were discussed and overlaps were identified. At the end of the workshop, each working group again reported its recommendations for FRDs to all the workshop participants. Each working group prepared a report that captured the research ideas and opportunities discussed in its sessions and the recommended FRDs. These results were integrated and are summarized below and described in detail in the full report.

1.2 Future Research Directions

The working groups initially identified 14 FRDs; however, these contained significant overlap and thus were combined to formulate 6 FRDs. The following FRDs are described in detail in the chapters that follow.

- Understanding, Predicting, and Optimizing the Physical Properties of Molten Salts
- Understanding the Structure, Dynamics, and Chemical Properties of Molten Salts
- Understanding Fission and Activation Product Chemistry and Radiation Chemistry
- Understanding Materials Compatibility and Interfacial Phenomena
- Guiding Next-Generation Materials for Molten Salt Reactors
- Creating a Virtual Reactor Simulation

References

1. E. S. Bettis, W. B. Cottrell, E. R. Mann, J. L. Meen, and G. D. Whitman. “The Aircraft Reactor Experiment—Operation.” *Nucl. Sci. Eng.* **2**, 841–853, 1957.
2. J. R. Engel, H. F. Bauman, J. F. Dearing, W. R. Grimes, and H. E. McCoy, Jr. *Development Status and Potential Program for Development of Proliferation-Resistant Molten-Salt Reactors*. ORNL/TM-6415, Oak Ridge National Laboratory, 1979

2. FRD 1: Understanding, Predicting, and Optimizing the Physical Properties of Molten Salts

2.1 Background and Current Status

The concept of a homogeneous, molten salt-cooled reactor was first envisioned in 1948 and its development is documented in many reviews [1]. The MSRE, the most significant MSR demonstration activity, operated at ORNL from 1965 until 1969. The results from that experiment and subsequent research have provided a wealth of material properties data and performance information that are thoroughly documented in the open literature. The MSRE was originally fueled with ^{235}U (and later ^{233}U) in a molten salt solution composed of ${}^7\text{LiF}$ - BeF_2 - ZrF_4 - UF_4 of the approximate composition 65-29-5-1 mol%. To appreciate the derivation of this fuel composition, one must recognize the numerous criteria and constraints behind it, which were described in detail by Grimes [2]. At the top level, neutronics (parasitic neutron absorption and moderating properties) limit the choice of nuclides that can be considered; those limits combine with the limits associated with the mission of the reactor (breeder, burner, or converter) and the neutron energies (fast or slow) in the system.

Figure 3 highlights the neutronic constraints that dictate the choice of elements for thermal and epithermal reactors (i.e., low neutron capture cross sections) and the chemical constraints that exert a controlling influence on all reactor applications. [3] The key criterion of the molten salt in a fluid-fueled reactor is that it must dissolve more than the critical concentration of fissile material (^{235}U , ^{233}U , or ^{239}Pu), dissolve a high concentration of fertile material (^{232}Th or ^{238}U), and dissolve all fission products without loss of useful properties or subsequent chemical reaction. It also must be stable toward reactor radiation and high operating temperature (500–750 °C), survive fission of uranium (or other fissionable materials), and possess a low vapor pressure over the entire performance envelope. The fluid must also possess heat transfer and hydrodynamic properties allowing it to serve as a heat-exchange fluid without excessive power requirements for circulation, and it must be relatively nonreactive with the metal reactor, heat exchangers, and moderator material (typically graphite). Finally, to achieve a low fuel cycle cost, the fuel should be inexpensive and economical to purify via efficient schemes designed to recover unburned fission and bred fissile materials and to remove fission products and neutron poisons.

The neutronic requirements for coolant salts are distinctly different from those for fuel salts (see Figure 2). For a primary coolant salt, low-neutron-absorbing-salts are necessary to obtain negative void and temperature coefficients [4]; whereas secondary coolant salts have no formal neutronic requirements, as the radiation intensities are significantly less, and the consequences of uranium fission and fission products are absent. In both cases, the coolant salt must be stable and compatible with the metal construction of the heat exchangers, have good heat transfer and hydrodynamic properties, have a low vapor pressure over a wide operating range (400 to over 900 °C), and not undergo a violent reaction with the fuel or steam in the event of a leak.

The requirement that fuel salts be compatible with the container material places a significant constraint upon the choice of salt constituents. It means that the cationic constituents of the salt must consist of relatively active, electropositive elements (e.g., fluoride compound free energies of formation >95 kcal/mol-F), whereas the container material must consist of elements that are relatively noble in comparison (e.g., fluoride compound free energies of formation <75 kcal/mol-F). [5] This requirement eliminates the middle of the periodic chart for consideration as salt constituents and the periphery of the periodic chart for consideration as alloy constituents (only a small region in the center is suitable for metallic alloys; see Figure 3). Nonmetallic materials (e.g., ceramics and composite materials) can also be compatible with a high-temperature salt—for example, graphite is known to be fully compatible with molten halides to very high temperatures. Although nonmetallic materials have been used and may find

service as core internals, there is currently no joining and fabrication technology for these materials to support their deployment as the container material for many of the complex components that will be in contact with the salt.

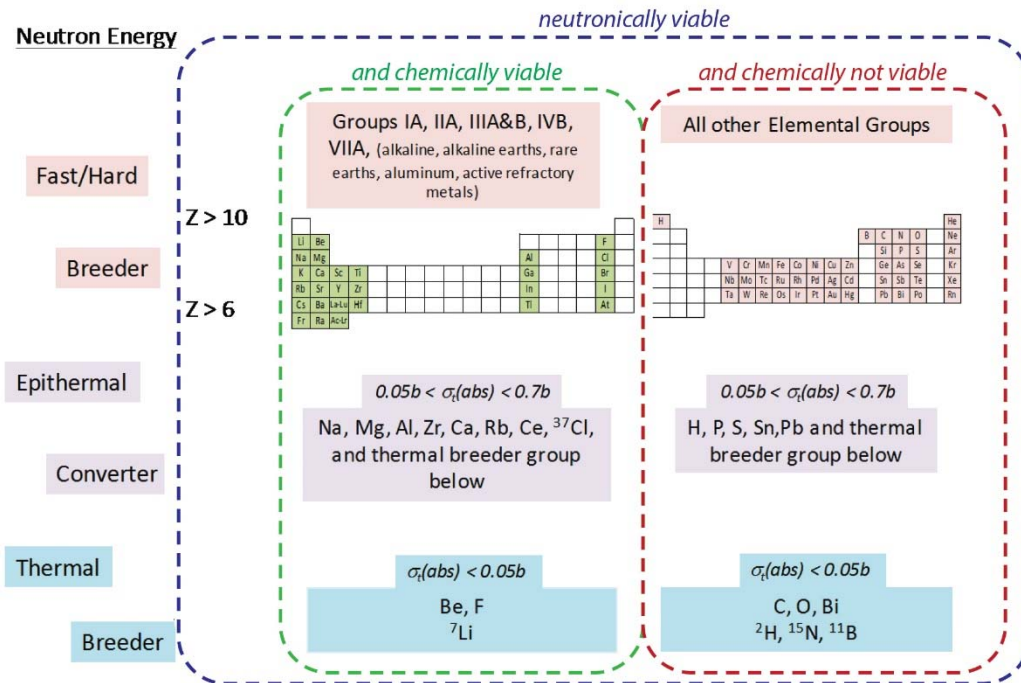

Figure 3. Early MSR program approach to screening and justifying candidate MSR salts (where $\sigma_t(abs)$ is total neutron absorption cross section). / Image courtesy of Oak Ridge National Laboratory

From a neutronics point of view, non-halide fluid-fueled systems (containing H, B, C, N, O, and Bi), such as oxides, carbonates, and nitrates, seem like reasonable choices. But they are either not chemically compatible with potential container materials or cannot dissolve enough fissile and fertile material at practical temperatures to serve as fluid fuels. Oxides typically have high melting points and are corrosive; carbonates also have a fairly high melting point and require a CO₂ over-pressure to stabilize them; and nitrates are problematic because of thermal decomposition and their stability in a high radiation field. Thus, combinations of ⁷Li⁺, Be²⁺, Al³⁺, Na⁺, Mg²⁺, and Zr⁴⁺ cations with F⁻ and ³⁷Cl⁻ stand out for use in fuel salts and primary coolants. (Note: ³⁷Cl⁻ is preferred because the major chlorine isotope [³⁵Cl] produces ³⁶Cl as an activation product, which is an unwanted long-lived energetic beta emitter.) For secondary coolant salts, there are no formal neutronic requirements; therefore, isotopic enrichment is not needed and so combinations of Li⁺, Na⁺, K⁺, Rb⁺, Mg²⁺, Be²⁺ and Zr⁴⁺ cations with F⁻, Cl⁻ or BF₄⁻ are viable [6]. There are limited thermodynamic data for candidate molten fluoride salt systems and even fewer data for candidate chloride salts systems (as shown in Figure 4).

Reactor salt options need to be optimized in the context of applications that address current needs, new capabilities, and material developments that have emerged since the MSRE. Over the past half-century, experimental, computational, and analytical methodologies have shown enormous advances and can be used to explore structure, properties, and reactivities of molten salts in considerably greater detail. In this light, this section focuses on the need for state-of-the-art investigations to understand, predict, and optimize the physical properties of molten salt systems that could be applied to MSRs and to obtain the data necessary to support reactor design/development.

	LiF	NaF	KF	RbF	CsF	BeF ₂	CaF ₂	LaF ₃	ZrF ₄	ThF ₄	UF ₄	PuF ₃	UF ₃	
	x	x	x	x	x	x	x			x	x	x		LiF
		x	x	x	x	x	x			x	x	x		NaF
			x	x								x		KF
				x									x	RbF
					x							x		CsF
						x							x	BeF ₂
							x							CaF ₂
								x						LaF ₃
									x					ZrF ₄
										x				ThF ₄
											x			UF ₄
												x		PuF ₃
													x	UF ₃
Binary														

	LiF	NaF	KF	RbF	CsF	BeF ₂	CaF ₂	LaF ₃	ThF ₄	UF ₄	PuF ₃		
	x	x				x		x	x	x	x	LiF-NaF	
		x	x									LiF-KF	
			x	x								LiF-RbF	
				x								LiF-CsF	
					x							LiF-BeF ₂	
						x						LiF-CaF ₂	
							x					LiF-LaF ₃	
								x				LiF-ThF ₄	
									x			LiF-UF ₄	
										x		NaF-BeF ₂	
											x	NaF-ThF ₄	
												x	BeF ₂ -ThF ₄
Ternary													

Figure 4. Available thermodynamic data (marked by an x) for binary and ternary fluoride salt mixtures for MSRs developed at the Institute for Transuranium Elements of the Joint Research Centre of the European Commission, Karlsruhe, Germany. | Capelli, E. *Thermodynamic Characterization of Salt Components for Molten Salt Reactor Fuel*, Fig. 1.2, PhD Thesis, University of Delft, 2016. http://samofar.eu/wp-content/uploads/2016/11/2016_Capelli_Elisa_PhD-thesis.pdf

2.2 Technical Challenges and Research Directions

2.2.1 Determining the Physical Properties of Molten Salts

Preparation and handling of high-purity salts

Although ORNL established processes and practices for purifying and handling fluoride salts for R&D and the MSRE, [7] there is no national standard for testing and reporting the purity of the salts. Different purification processes and procedures are needed for other salts (e.g., carbochlorination for chloride salts). [8] Purification methods are needed not only to eliminate cationic metallic impurities and corrosive moisture, oxides, and hydroxides in the hygroscopic halide raw materials, but also to eliminate corrosive anionic contaminants such as sulfates, sulfides, and carbonates. It is necessary to positively identify salt impurities and quantify the degree of purity achieved. In some cases, this may require going beyond previous practices, especially for new salt systems. Such purification protocols and tabulated data sets are readily available in the literature for organic reagents and solvents, but complementary data and standardized and validated methods do not exist for halide salts intended for nuclear service. The development of protocols amenable to the production of high-purity salt will also require scaling to production levels and transferring proven methods and defined purity requirements to commercial vendors to facilitate more widespread availability of pure, quality-assured salts to accelerate research.

There are many challenges to the accurate measurement of the high-temperature thermophysical properties of MSR salts. First, a wide range of salt and fuel compositions must be considered, including fission products and transuranic elements produced during power production. Each component requires extensive purification to remove impurities—such as oxides, sulfides, metals and water—which demands the use and engineering of specialized containers that not only are compatible with the salt but also will rigorously maintain salt purity. For highly accurate determination of salt physical properties, contaminants (e.g., atmospheric moisture) must be rigorously excluded following purification and during property measurement. *To these ends, purification procedures need to be developed, externally validated, and published in the open literature; and a single source of pedigreed salt should be established for the production of analytical standards for the research community.* Meeting those needs would advance our knowledge and confidence in the physical properties of the molten salts, since the community would be working with materials of similar quality. A primary contribution to the overall scientific and technical program would be a supply of pedigreed salt from which institutions could obtain small quantities to serve as standards to validate the purity of larger salt quantities.

For large-scale experiments, analytical-grade salts available from commercial suppliers are of insufficient purity to accommodate meaningful investigations of molten salt behavior and the reliable characterization of physical properties essential for predictive modeling efforts and fuel qualification. Both phase behavior and corrosion responses are especially sensitive to small amounts of impurities. Previous work on the MSRE at ORNL revealed that minimal salt loop corrosion was achievable when care was taken to afford a high-purity salt that was preserved under air-free and moisture-free environments. Modest corrosion rates (0.013–0.044 mm/year) have been obtained for purified salts in a closed loop, [9] whereas salts that were used as received and remained open to atmosphere corroded containments more than four orders of magnitude more rapidly (up to 167 mm/year). [10] This vast difference in corrosion response highlights the *need to develop a series of best practices in the production, purification, characterization, and handling of molten salts, as well as a means by which the pedigree and reliability of the reported data can be assessed by the scientific community.*

The current standard for quality assurance of nuclear fuels and material is Nuclear Quality Assurance-1, established by the American Society of Mechanical Engineers. *There is a need to establish a quality assurance hierarchy for molten salt preparation and characterization with commensurate measurement, documentation, and reporting criteria explicitly documented.* Such an approach will improve confidence in reported results and allow the research community to meaningfully contribute to the collection of high-quality data required for fuel validation or development of predictive models. For the purposes of ensuring instrument calibration and good quality control practices, a single source of salt should be established for the production of analytical standards for purified, pedigreed salt. Additionally, experimental documentation and representative metrics of data quality need to be accessible for external reproducibility, validation, and verification. An example of such a system is the Cambridge Crystallographic Database, which serves as a free repository for single crystal data sets. Crystal data can be independently analyzed before they are uploaded, enabling the creation of a “checkcif” file that articulates any suspicious metrics in the proposed structure. These documents are peer-reviewed before publication of the crystal structure and preserved for subsequent inspection as needed. A similar review, documentation, and archival infrastructure is necessary to enable the reliable determination of salt properties and to facilitate future molten salt characterization and MSR development.

Defining phase diagrams of molten salts

The primary tool for understanding fuel and coolant salts is the phase diagram—as it defines the temperature-composition space for single-phase liquids; the order and identity of equilibrium phases that crystallize as the melt freezes; and the solubility of constituents that can grow, such as transuranics, fission products, corrosion and activation products, and impurities. A variety of phase transitions occur in molten salts: in a few instances, the melt and frozen solid have an invariant composition throughout the freezing process (i.e., the line-compound composition); in most instances, the transition is more complex and the frozen solid is different from the melt composition in a variety of ways; and in rare instances, two immiscible liquids can form or a melt may cool to a metastable phase that remains liquid below the indicated melting temperature of the mixture. [11]

A large number of binary and ternary phase diagrams have been measured for chloride and fluoride salt systems, [12] and a small number of higher-order systems have been characterized over the years (see Figure 5). The methods used to determine the phase diagrams include differential scanning calorimetry, electrochemical methods, and solidification along a temperature gradient [13–16]. Since a number of the species are volatile, their vapor-liquid and vapor-solid equilibria need to be known, along with additional thermodynamic data, to provide a complete understanding of the phase behavior.

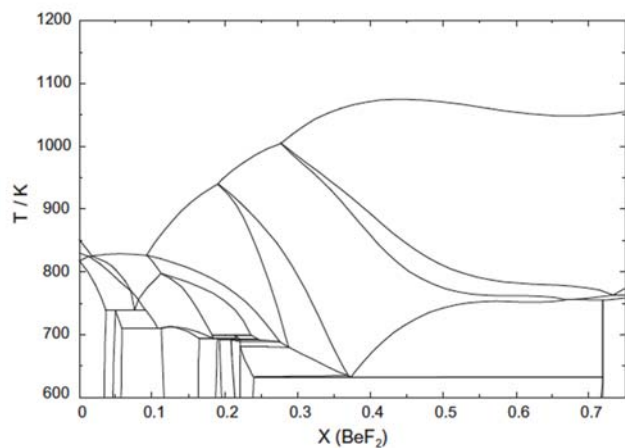

(a) Calculated LiF-BeF₂ pseudo-binary phase diagram with fixed concentration of UF₄ (2.55 mol%) and ThF₄ (19.95 mol%).

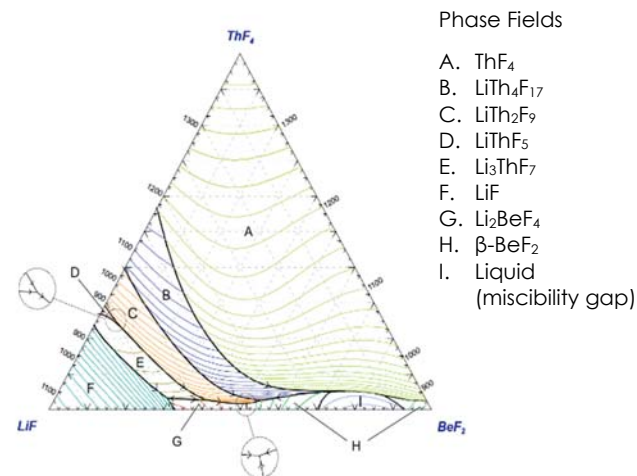

(b) The liquidus projection of the LiF-BeF₂-ThF₄ system.

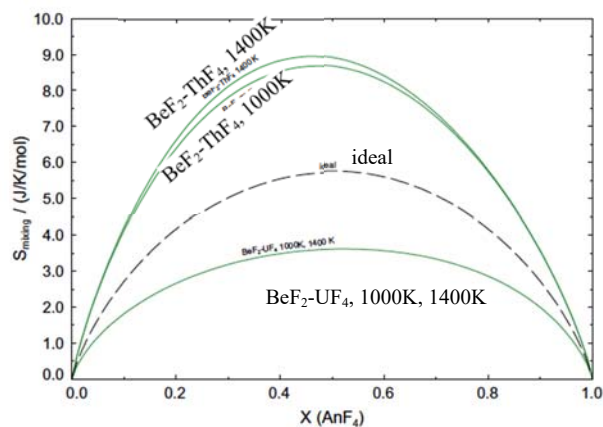

(c) Calculated entropy of mixing: BeF₂-AnF₄ (An=Th, U) 1000 K and 1400 K.

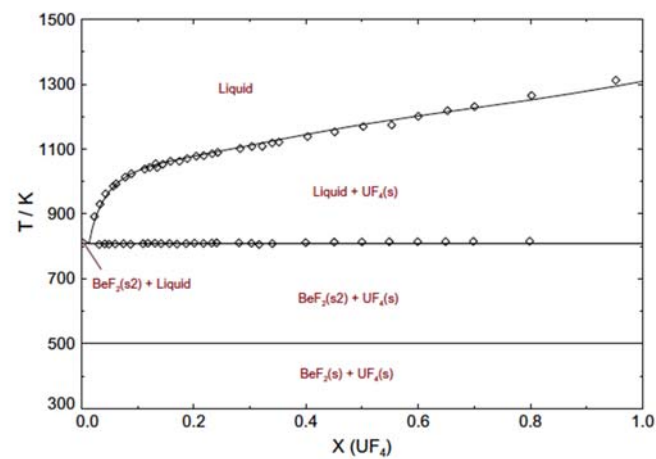

(d) Optimized BeF₂-UF₄ phase diagram.

Figure 5. Representations for integrating phase diagram understanding. | Reprinted from J. Nucl. Mater. 449, E. Capelli, O. Beneš, and R.J.M. Koning. "Thermodynamic assessment of the LiF-NaF-BeF₂-ThF₄-UF₄ system." 111–121, 2014, with permission from Elsevier.

Previous methods of determining phase diagrams of molten salt mixtures used a relatively large number of samples and were highly labor intensive. The rigorous control and measurement of impurities—including dissolved metals, oxygen-containing impurities (e.g., oxides, hydroxides, sulfates, carbonates, oxyhalides), water, and other types of impurities—were not always reported. Therefore, it is difficult to ascertain the accuracy of some of the existing phase diagrams in the literature. For some systems, there are discrepancies among various studies that have yet to be reconciled. These flaws reinforce the need for a source of high-purity salts and for the publication of complete analytical approaches and experimental practices used to obtain data sets.

The phase diagram is also a manifestation of the thermodynamics of the system, as equilibrium is determined by the Gibb's free energy of the system. Thermodynamic properties of each of the components (including their heats and entropies of fusion) and mixing properties within phases of varying compositions define the Gibb's free energy. If the thermodynamic properties are known, the phase diagram can be calculated, using various established formalisms [17]. Conversely, thermodynamic properties can be extracted from the phase diagram.

The thermodynamic properties of a system are determined by the atomic-level structure and inter-atomic interactions. Modern spectroscopic techniques (as described in Section 3) can provide insights into the structure and dynamics of molten salts and can be used to validate computational models. Ab-initio calculations can be used to guide the prediction of thermodynamic properties and identify the appropriate forms of equations for calculating phase equilibria. Comprehensive databases, which are just beginning to be developed from data produced decades ago, can be used for data mining and for compiling and reconciling data to gain insights into thermodynamics properties of molten salts and develop more complex thermodynamic models. *An improved way to query and visualize phase diagram and thermodynamic databases is recommended, which would support more strategic thinking about the development of new chemical systems and help in developing more comprehensive thermodynamic models.*

Computational methods and databases can accelerate the collection and analysis of thermodynamic data and phase diagrams. As a starting point, *we need to assess prior studies and identify missing data, compositions, and thermodynamic accuracy gaps in the experimental data for binary, ternary, and higher order multi-component systems.* Recommended research directions include the following:

1. Use computational studies to define where additional experimental data are most needed. Experimental data should be taken in regions where the activity coefficients vary sharply, where there is evidence for short-order and complex-ion formation, from computational and experimental studies of salt structure and speciation, and for new systems under consideration.
2. Develop advanced methods of high-throughput data collection, with well-quantified uncertainties, that are applicable to air- and water-sensitive high-temperature salts containing radionuclides and other toxic elements. For example, high-throughput phase diagram determination might entail spectroscopic interrogation of an array of simultaneously heated samples, or of a sample of given composition exposed to a temperature gradient. Approaches for obtaining meaningful data for salts containing volatile fission and activation products are also needed; experiments performed under modest pressures may overcome some of these challenges, but such an approach also requires validation against known phase diagrams.
3. Develop high-purity calibration standards of known pedigree for use in analytical studies using multiple experimental methods for thermodynamic data collection. It is critical to validate newly developed methods on well-characterized simple systems, as well as to include quality control samples during data collection in compliance with good analytical practices.

4. Identify and investigate potential metastable phases induced by ionizing radiation and compositional changes due to fission, activation, and decay.
5. Validate density functional theory (DFT) and ab initio molecular dynamics (AIMD) calculations performed on known salts with experimental data and spectroscopic characterization, followed by modeling of thermodynamic properties of systems that are new or difficult to measure experimentally, (e.g., containing higher actinide activation products).
6. Develop appropriate thermodynamic models for use as a predictive tool, enabling investigation beyond conditions that can be experimentally measured (e.g., short-lived fission products or highly activated sample). Database development requires selecting appropriate theoretical models for each specific system, then computationally optimizing the input thermodynamic parameters to match available experimental data points. One of the challenges is development and application of the appropriate thermodynamic model for each specific system. The question of appropriate entropies of mixing is a particular challenge because of the complex speciation, and the possibility of short- to mid-range molecular order in the salt.
7. Develop tools to query salt property databases and visualize information in a way that is accessible to a variety of users and most useful in design and safety analysis. Recent developments in modern computing, data visualization, and user-interface tools need to be translated to those ends. The ability to trace the results of a query to the initial data sources, accompanied by experimental details, can take advantage of modern database and content management tools. Uncertainty quantification, error propagation, and sensitivity analysis should be integral to these models. Such analysis will also indicate where more experimental data are needed. The user interface will expand the community, which will also help with prioritization of data needs.

Thermodynamic and thermophysical property determination

In addition to phase behavior, other important physical properties need to be measured for the individual salts and mixtures of salts, including melting point, density, viscosity, heat capacity, thermal conductivity, vapor pressure, heat of fusion, expansivity, compressibility, surface tension, and gas and fission product solubilities. [18] Some physical properties (such as solubility, vapor pressure, and viscosity in the neighborhood of glass-forming domains) are sensitive to slight compositional changes; and the properties change rapidly, further underscoring the need for established purification protocols, high-purity salts, and rigorous analytical practices (Section 2.2.1). Given the number of measurements that need to be made, high-throughput experimental techniques that can be miniaturized and are amenable to operation in a glovebox environment could greatly accelerate property measurements and technology development. However, the need for high-throughput measurements must be balanced against and coordinated with the need for high-precision reference measurements. This subsection provides examples of some state-of-the-art reference measurement techniques that may be miniaturized for high-throughput measurements. This discussion is not comprehensive but provides some examples of measurement techniques to inspire the reader. It must be stressed that most of these property measurement capabilities for extreme temperatures and controlled atmosphere are not off-the-shelf capabilities. They are typically customized systems with specialized procedures that are not standardized.

Calorimetry

Calorimetric methodology and sensitivity have been improved over the past three decades. A calorimeter suitable for high-temperature solution calorimetry is now commercially available and is being used in several laboratories at both universities and national labs. Heats of formation and transformation can typically be measured with an accuracy of $\pm 1\text{--}3$ kJ/mol for sample sizes of 10–100 mg. Heats of mixing, heats of fusion of binary and ternary fluorides and chlorides, heats of formation of crystalline ternary

compounds, and heats of dissolution of fission products and other impurities in molten salts as a function of both molten salt composition and solute concentration can all be measured by calorimetric methods. However, the precision and accuracy of such measurements will depend critically on the purity of the starting materials.

Differential scanning calorimeters (DSCs) can provide heat capacities, melting points and heats of fusion/crystallization. Their accuracy in heat capacity measurements is of the order of 1–2% at room temperature to 500 °C and 2–5% at 500–1200 °C. Heats of phase transition and fusion can be determined at an accuracy of 1–5%, depending critically on appropriate calibration standards. Temperature accuracy below 1000 °C is generally on the order of ± 1 °C. There are opportunities to adapt these methods to radionuclides and air- and water-free environments. Sample containment—especially because of sample creep along container walls—and materials compatibility pose challenges. *New high-throughput methods on multiple samples, perhaps combining calorimetric and spectroscopic techniques, should be developed.*

Viscosity Measurements

A number of different methods (e.g., rotational, capillary) have been used for molten salt viscosity measurement. [19] The miniature rolling-ball viscometer (Figure 6) uses an induction coil for rapid heat-up and measurement of the rolling ball velocity (μ) as a function of inclination angle (θ). With this method, it is possible to determine the viscosity of molten salts in a range of 1–5 mPa·s at temperatures of up to 1400 °C. However, a set-up needs to be designed to use less than 10 mL of flux and use interchangeable tubes with rolling balls.

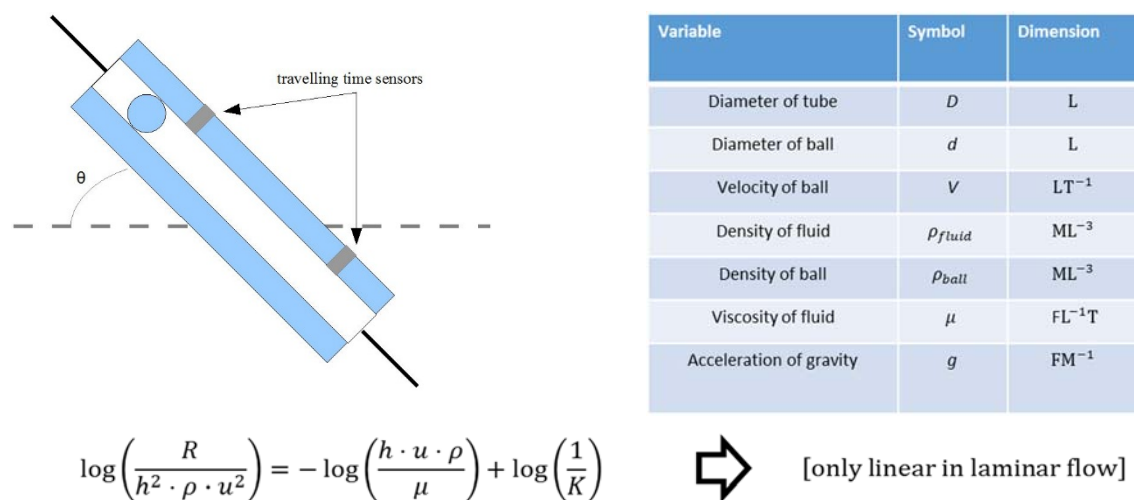

Figure 6. Miniature rolling-ball viscometer description. | Image courtesy of Prof. Uday Pal, Boston University

Thermal Diffusivity and Thermal Conductivity

Optical techniques based on both emission spectroscopy and modulated heating have the potential to measure radiative and thermophysical properties that govern temperature in a molten salt. To determine thermophysical properties, such as thermal diffusivity or thermal conductivity, *thermal lens spectroscopy* can be implemented. [20] This technique uses an acousto-optical modulator to provide modulated laser heating of the liquid at a small focal point. A probe laser beam is passed through the focal region and is affected (broadened or deflected) by the change in refractive index caused by the heating beam. This change produces in turn a change in the detected laser intensity, and the resulting signal can be fit to heat transfer models to determine the thermal conductivity and thermal diffusivity of the fluid.

The thermal lens technique has the added benefit of being able to provide an independent measurement of the absorption coefficient of a fluid by a rearrangement of the lasers and detectors. [21]

Molar Volume and Electrical Conductivity Measurement

Combined density and electrical conductivity (ionic and electronic) can be measured using coaxial electrodes that measure AC impedance spectra and DC currents as a function of electrode depth in the salt (Figure 7). Using the cell geometry and the measurement data, salt height at temperature, molar volume, and ionic and electronic conductivities can be determined. Furthermore, the partial ionic conductivities and the chemical diffusivities of species can be extracted from separate transference number measurements. [22]

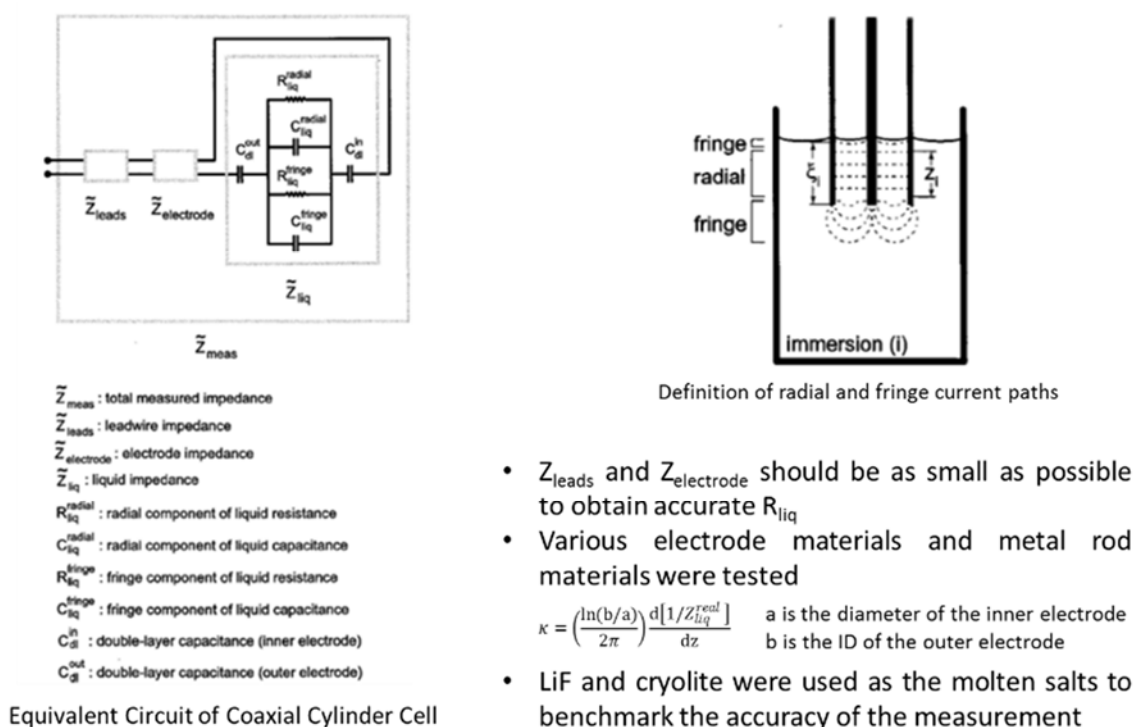

Figure 7. Electrical method for measuring molar volume, ionic and electrical conductivity. | Reprinted from S. L. Schiefelbein, N. A. Fried, K. G. Rhoades, and D. R. Sadoway. A high-accuracy, calibration-free technique for measuring the electrical conductivity of liquids. *Review of Scientific Instruments*, 69(9), 3308–3313, 1998, (<http://dx.doi.org/10.1063/1.1149095>), with the permission of AIP Publishing.

Surface Tension and Contact Angle

A precise bubble pressure technique can be designed to measure surface tension by immersing an appropriate metal tube in the selected molten flux, blowing gas through the tube to acquire a surface tension value between the gas and the liquid salt, and examining the peak pressure exerted on the gas by the liquid (Figure 8). In many cases, contact angle is the key piece of information for understanding interfacial behavior (foaming, intrusion into pores, and wetting surfaces). Additional techniques that can yield both contact angle and surface tension are the sessile drop technique and the Langmuir-Wilhelmy plate method. The sessile drop method uses a very high-shutter speed camera and an optical setup to take an image of a molten flux piece resting on an appropriate substrate. This allows measurement of a contact angle at a three-phase interface (Figure 8). Using this contact angle, the solid-liquid surface tension can be

estimated. Each of these methods has advantages and disadvantages that will need to be considered based upon the system being investigated, the type of information desired, and the required accuracy. [23]

Maximum bubble pressure method:

- A capillary tube is inserted into the liquid, the change of pressure inside the capillary tube is recorded as gas was purged into the tube to form bubbles

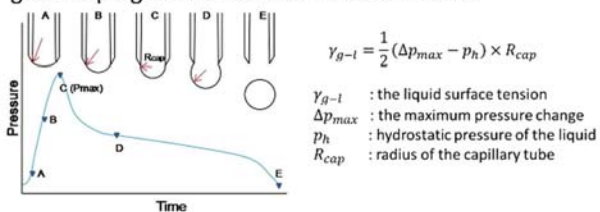

Change of pressure during bubble formation as a function of time

Sessile drop observation

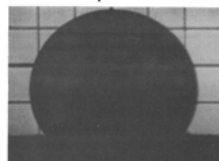

Image of the molten drop of cryolite on a graphite plate

$$\cos \theta = \frac{\gamma_{g/s} - \gamma_{l/s}}{\gamma_{g/l}}$$

$\gamma_{g/s}$: Solid surface tension
 $\gamma_{l/s}$: Liquid solid interaction energy
 $\gamma_{g/l}$: Liquid surface tension
 θ : Contact angle

- Direct observation of wettability between liquid and solid surface
- Surface interaction energy can be calculated based on surface tension values (literature and experimental data)

Figure 8. Interfacial measurement methods. (a) Bubble-pressure method for measuring surface tension. (b) Sessile-drop method for measuring contact angle and surface tension. | Image courtesy of Prof. Uday Pal, Boston University

Volatility and Melting Point

The melting point and volatilization rate of the salt as a function of temperature can be measured using a simultaneous DSC and thermogravimetric analysis (DSC/TGA) balance. To ensure salt purity is preserved, the instrument needs to be designed for operation in an inert-atmosphere glovebox. Although the recorded weight change of the TGA can be attributed to salt volatilization, the weight change is dependent upon salt purity (Section 2.2.1). Volatile species can be determined, both for understanding salt properties and for validating salt purity, by quadrupole mass spectrometer analysis or by condensing volatilized species on a water-cooled substrate with subsequent analysis by x-ray fluorescence, x-ray diffraction (XRD), or other techniques. [24] For measuring low vapor pressures, the traditional transpiration method is reliable and accurate and can be used as a reference method in this domain. It does not require significant deployment of sophisticated instruments within an inert envelope. [25]

Solubility

Small, thin capillary tubes containing the salt can be rapidly heated and quenched. The tubes with the salt can be placed in contact with the compound for which the solubility needs to be measured. Both the solubility and the diffusivity of the dissolving compound can be estimated by measuring the diffusion profile of the quenched sample (Figure 9).

EMF Technique for Chemical Activity and Phase Diagrams

The electromotive force (EMF) generated by electrochemical cells can be used to measure the partial molar Gibbs energies, activity, and activity coefficients, and to determine the phase diagram. For example, the phase diagram of Ba-Bi system was determined by the EMF technique using a CaF_2 - BaF_2 binary electrolyte at 450–800 °C. [26] This technique is potentially powerful, as it is possible to define both the thermodynamic properties of the system and the phase diagram that will delineate liquid-state solubility, solidus temperature, and phase fraction/composition.

Solubility Measurement Setup

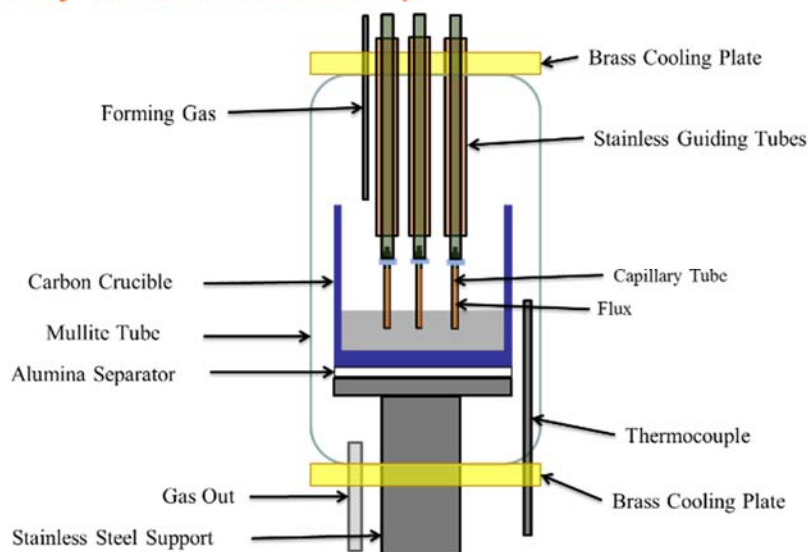

Figure 9. Rapid-quenched capillary setup for specie solubility and diffusivity. / S. Su, T. Villalon Jr., U. Pal, and A. Powell. "Techniques for measuring solubility and electrical conductivity," pp. 465–475 in *Advances in Molten Slags, Fluxes, and Salts: Proceedings of The 10th International Conference on Molten Slags, Fluxes and Salts (MOLTEN16)*, Eds. R. G. Reddy, P. Chaubal, P. C. Pistorius, and U. Pal. TMS (The Minerals, Metals & Materials Society), 2016. Used with permission of Springer.

2.2.2 Predicting the Chemical Speciation, Structure, and Dynamics of Molten Salts Solutions

Computational salt chemistry is a major scientific challenge because of the complex nature of the salts. Although there has been prior work showing the value of molecular modeling with interatomic potentials to predict molten salt properties, [27] only a few studies of molten salts have used a fully first principles approach capable of explicitly treating polarization effects and chemical reactivity. [28] Looking forward, optimized approaches are needed which employ first-principles MD simulations of a molten salt system that are validated against existing experimental data. To develop those approaches, the basic thermodynamic and kinetic properties of molar volume, thermal expansion, bulk modulus, and diffusivity, for a molten salt at multiple temperatures, need to be computed. Simulations for pure molten chloride/fluoride salts at multiple temperatures are needed to obtain temperature-dependent thermodynamic, kinetic, and transport properties; and speciation information is clearly needed for the prediction of salt phase diagrams and other physical properties. In addition, knowledge of the constituents is needed to understand interfacial behavior leading to MSR material degradation, such as corrosion.

Another complexity in computational salt chemistry is that the atomic composition of the salt changes as a function of time as a result of fission product formation and the emission of α , β , and γ -rays, which can lead to radiolysis in solid salts. In the molten salt, our understanding of the transient chemistry associated with fission and decay is limited, but what has been observed over longer time periods is that much of the energy that is deposited in the salt works to restore the salt to an equilibrium composition; and few structural changes are observed in the salt. Compositional and redox changes arise as results of transmutation and fission (loss of fissile species, grow-in of soluble fission products). Chemical evolution of the insoluble fission products, at all time scales, remains an open question. Computational electronic structure and MD methods can be used to extend the limited experimental data sets to cover a broad range of parameter space. However, these predictions must have the appropriate accuracy required for upscaling

across multiple time and length scales. For example, nucleation is very sensitive to the rate constants used. An error of 0.3 kcal/mol in a reaction step at the MSR operating temperature of ~ 600 °C can lead to an overall error in the equilibrium prediction by a factor of about 850 over 40 steps. [29]

Furthermore, the importance of experimental validation of computationally-predicted results cannot be overemphasized. In previous research studies, computational methods were applied that incorrectly predicted molten salt structure and were unable to predict the intermediate structure that was later demonstrated experimentally. [30] The power of predictive approaches is that they provide the ability to investigate systems under time scales and conditions that are not experimentally accessible; therefore demonstration of performance accuracy under experimentally testable conditions is an important prerequisite for computational development. Techniques suitable for physical characterization are discussed in detail earlier, and spectroscopic approaches capable of providing structural details at the atomistic and intermediate length scales are discussed in Section 3.

Successful development and validation of this computational research approach will enable a new capability that goes beyond the traditional approach to optimizing molten salt composition with respect to fuel and fission product solubility, thermophysical properties, and in-reactor salt degradation. It will also minimize corrosion/degradation of materials of construction for the reactor, pump, and heat exchanger components.

Building Accurate Multi-component Models for Prediction of Phase Diagrams

The phase equilibria and thermochemistry of fluoride and chloride molten salts can be well represented by existing modeling frameworks (Figure 10). While free energies and solution parameters for a number of the proposed components are available, numerous critical elements are missing in the datasets. *High-throughput first-principles techniques and experimental methods need to be developed to efficiently provide phase equilibria and thermochemistry information.* The models will then need to be expanded to include any additional components, and validated experimentally. Solution models for viscosity will also need to be developed, possibly based on the demonstrated successful correlations in oxide liquids. Importantly, parameters such as constituent solubility, oxidation state, and coordination environment need to be experimentally determined to allow theoretical models to accurately reproduce and predict the physicochemical behavior of the melts.

Applying Molecular Dynamics Simulations to Predict Thermophysical and Transport Properties

It is important to be able to accurately predict and understand liquid structure and dynamics both in the bulk and at salt/material or salt/vapor interfaces. MD simulation can help explain transport properties, including viscosity and the origin of different length-scale features in the x-ray structure function, $S(q)$, as well as real-space radial distribution functions. It can also be particularly useful in understanding the effects of structural voids and defects formed under radiolytic conditions, as well as determining their effects on material transport and thermal conductivity. This is particularly important for understanding possible structural heterogeneities in the molten salt system. MD simulation can be used to understand wetting and permeation at degraded interfaces where surface energies are important, and to describe salts under confinement within graphitic or other structural materials when thermodynamic models are insufficient. AIMD will be needed for processes in the condensed phase in which reactivity may be important.

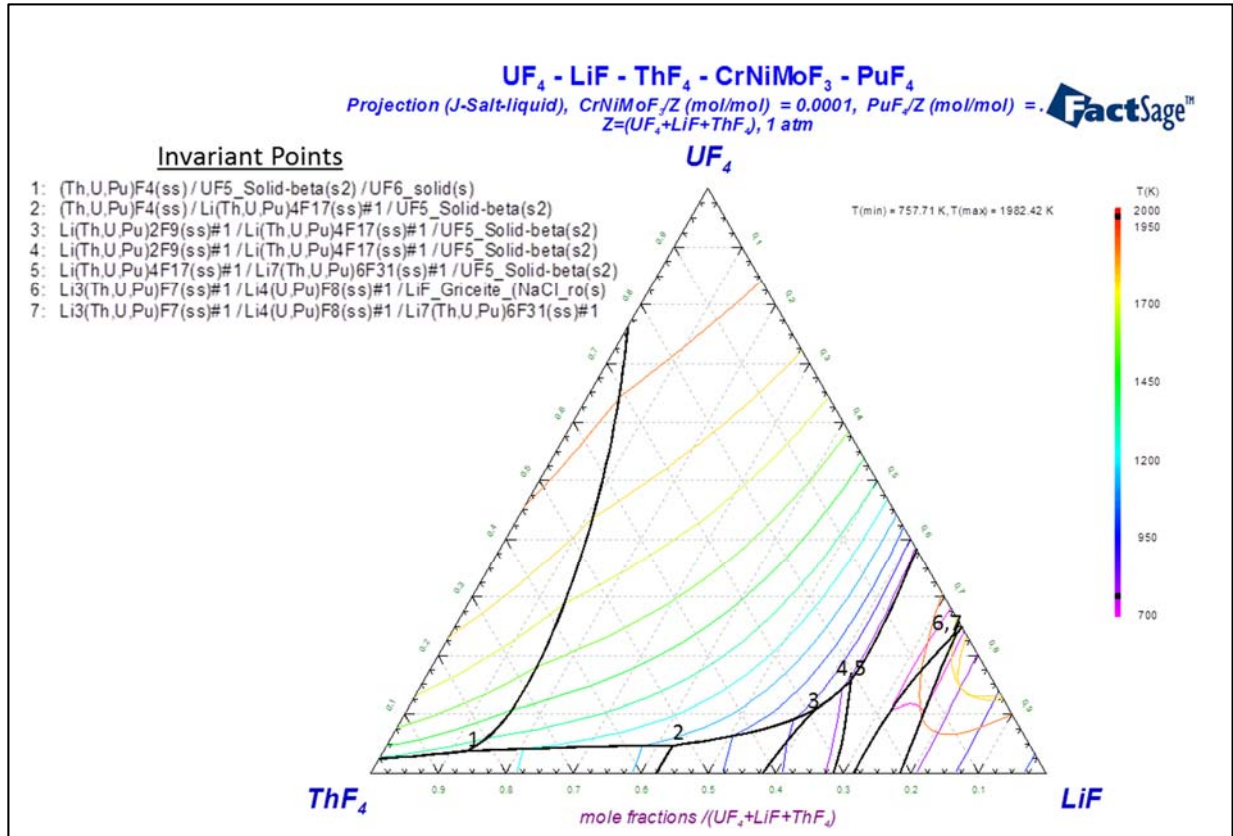

Figure 10. Illustrative phase diagram of invariant points and liquidus projections for a fluoride fuel salt with a minor amount of Pu and low concentrations of Cr, Ni, Mo. (Diagrams and data such as this will be needed for MSR complex salt chemistries.) | Image computed from existing molten salt databases; courtesy of Prof. Ted Besmann, University of South Carolina

A simplistic view of a MSR salt fuel is a set of cations, which are changing their identity and their oxidation states (through nuclear transmutation and fission), embedded in a sea of fluoride or chloride anions. The interactions of the cations with the anions is thus quite complex, especially considering dynamic oxidation states. The current approach is to fit a classical potential model to a set of results from first-principles electronic structure calculations; if other liquid state data are available, such as densities or diffusivities, they can also be used to improve parameterization of the model. This approach can work well if enough configurations can be sampled and there are no changes in the oxidation state or the valency (number of “bonds” to a center). However, modeling more complex systems will require many different force field interactions, with a concomitant increase in complexity. Thus, to treat the atom-atom interactions, different approaches are needed that are not necessarily biased by the input force field and can account for changing oxidation states and the presence of open shells due to unpaired electrons. One approach would be to employ fast electronic structure methods for the atom-atom interactions, for example, semi-empirical molecular orbital theory (SEMO) [31] and tight binding DFT (TB-DFT). Such methods require parameterization, but they can be tuned for the atom and oxidation state in a straightforward manner by comparison to high-level first-principles electronic structure calculations at the correlated molecular orbital theory or DFT levels. [32] Even though these approaches have the advantage of being able to deal with changes in electronic structure, they have some disadvantages: (1) the time scales that can be simulated are short; and (2) calculations of liquid structural properties, such as the x-ray structure function $S(q)$, and dynamical properties, such as diffusion constants and viscosity, are not guaranteed to be superior to those derived from classical simulations. Therefore, experimental validation is an irreplaceable aspect of atomistic modeling.

Computational approaches also need to be developed to bound uncertainties in the results obtained from simulations of molten salt systems to provide useful information for system models. It is critical to provide error bars from the computations either through careful analysis of each term in the modeling, as has been done for first-principles electronic structure of thermodynamic properties, or through proper sampling. Current approaches for the latter case are usually based on Monte Carlo sampling, which is computationally very expensive. New mathematical approaches are needed for more efficient uncertainty analysis.

Ultimately, quantum mechanics, classical dynamics, coarse-grained models, continuum models, and thermodynamic models must be integrated to achieve predictive insights ranging from chemical reactivity at the atomistic level to bulk thermophysical and transport properties. Computational studies will require large simulation sizes on the orders of tens of millions of atoms to cover the required spatial scale. Such simulations will require access to DOE's highest-performance computers alongside optimized exascale software. For example, new and proposed heterogeneous computer architectures, such as graphics processing units, may require improvements in the software to attain optimal performance.

Impact of Advanced Modeling

The ability to model physicochemical properties of molten salts and predict optimal compositions, enabling a “materials by design” approach, would dramatically increase the rate of scientific advance. Identification of promising melt compositions could be performed predictively, allowing for experimental validation of promising compositions, rather than through brute-force approaches requiring large investments of time, money, and material. Furthermore, predictive modeling allows for the interrogation of conditions beyond what can be investigated by traditional experimental approaches, such as prolonged exposure (years to decades) to elevated temperatures and extreme radiation fields.

A core capability will be the ability to design molten salts from a combination of simulation and experimental results with the appropriate chemical and physical properties that will provide optimal operation in a MSR. This will include the choice of an appropriate combination of anions and cations with the best set of properties to provide reactors that have long lifetimes and can be safely operated with maximal efficiency. An advantage of simulations is their ability to model complex mixtures with many cations in different compositions, covering a much broader range of parameter space than can be done experimentally in a shorter time.

Addressing these scientific challenges will enable scientists and engineers to improve the modeling and simulation of MSRs, including the underlying physicochemical phenomena captured in the transport properties used in the continuum theories of momentum, mass, and energy transfer used to design nuclear reactors. This will allow predictions of effective diffusivities of fission products in complex molten salts, thermal conductivity, and viscosity, which are parameters used in the traditional modeling and simulation approach for reactor design. It will enable prediction of the nature and fate of volatile products, including release rates. The data generated can be used to extrapolate limited experimental data into broader areas of parameter space for use in reactor design, including new and improved materials. They will be able to predict the nucleation and growth of insoluble products within a flowing molten salt and be able to bound the uncertainty in our knowledge of molten salts.

The ability to predict the chemical and thermophysical properties of molten salts over a broad range of temperature and composition will have significant impact on fields beyond MSR. *A near-term goal should include the development of a global thermodynamic model of MSR salts that is valid under a broad range of conditions.* This will be of great value to the reactor design community, and these approaches can be applied to the design of other reactor systems, as well as complex industrial processes. The tools and approaches developed for the design of molten salts will help enable the prediction of

chemical properties under ionizing radiation conditions for other materials, in particular because of the necessary validation of computational data against an extensive experimental data set. The development of new MD approaches is required for simulations of complex systems over long times; and new approaches for the development of force fields and fast electronic structure methods will be broadly used by the simulation community for other systems, especially for materials and ionic liquids. [33] Finally, the ability to reliably predict the solubility of fission products in salts will lead to new concepts of solvation, which will be broadly used by the MSR community and others investigating the diverse industrial applications of molten salts.

References

1. M. W. Rosenthal, P. R. Kasten, and R. B. Briggs. "Molten-salt reactors—History, status, and potential." *Nucl. Appl. Tech.* **8**, 107–117, 1970.
2. W. R. Grimes. "Molten-salt reactor chemistry." *Nucl. Appl. Tech.* **8**, 137–155, 1970.
3. W. R. Grimes and D. R. Cuneo. "Molten salts as reactor fuel," in *Reactor Handbook*, vol. 1, *Materials*, ed. C. R. Tipton Jr., C. R. Interscience Publishers, New York, 1960, 2nd ed., p. 425
4. D. F. Williams, and K. T. Clarno. "Evaluation of salt coolants for reactor applications." *Nucl. Technol.* **163**(3), 330–343, 2008. http://www.ans.org/pubs/journals/nt/a_3992
5. W. R. Grimes. *Chemical Research and Development for the Molten-Salt Breeder Reactor*, ORNL/TM-1853, Oak Ridge National Laboratory, 1967. <http://web.ornl.gov/info/reports/1967/3445605995384.pdf>
6. D. F. Williams. *Assessment of Candidate Molten Salt Coolants for the NNGP/NHI Heat-Transfer Loop*, ORNL TM-2006/69, Oak Ridge National Laboratory, 1960
7. J. H. Shaffer. *Preparation and Handling of Salt Mixtures for the Molten Salt Reactor Experiment*, ORNL-4616, Oak Ridge National Laboratory, 1971; C. E. Bamberger, "Experimental techniques in molten fluoride chemistry" in *Advances in Molten Salt Chemistry*, vol. 3, ed. J. Braunstein, G. Mamantov, and G. P. Smith. Springer US, 1975. DOI: 10.1007/978-1-4615-8270-0
8. V. L. Cherginets. "Acid-base equilibria in ionic solvents," chapter 10.4 in *Handbook of Solvents*, ed. G. Wypych. ChemTec Publishing. Toronto, 2001, pp. 633–635; V. L. Cherginets and T. P. Rebrova. "Studies of some acid-base equilibria in the molten eutectic mixture KCl-LiCl at 700 degrees C." *Electrochim. Acta* **45**(3), 469–476, 1999.
9. H. Susskind, F. B. Hill, L. Green, S. Kalish, L. E. Kukacka, W. E. McNulty, and E. J. Wirsing. *Corrosion Studies for a Fused Salt-Liquid Metal Extraction Process for the Liquid Metal Fuel Reactor*, BNL-585, Brookhaven National Laboratory. US Atomic Energy Commission. 1960.
10. B. Mishra, and D. L. Olson. "Molten salt applications in materials processing." *J. Phys. Chem. Solids* **2–4**, 396–40, 2005.
11. J. E. Ricci. *Guide to the Phase Diagrams of the Fluoride Systems*, ORNL-2396, Oak Ridge National Laboratory, 1958; J. E. Ricci. "Phase diagrams of fused salts," in *Molten Salt Chemistry*, ed. M.

- Blander. 1964. 239–365; R. E. Thoma. “The role of phase equilibria in molten salt research” in *Molten Salts—Characterization and Analysis*, ed. G. Mamantov. Marcel Dekker, NY, 1969, 81–119.
12. E. M. Levin, C. R. Robbins, H. F. McMurdie. *Phase Diagrams for Ceramists*, ed. M. K. Reser. American Ceramic Society, multiple volumes 1964–1992; R. E. Thoma. “Phase diagrams of binary and ternary fluoride systems.” Chapter 6 in *Advances in Molten Salt Chemistry*, vol. 3, ed. J. Braunstein, G. Mamantov, and G. P. Smith. Springer US, 1975. 275–455.
 13. L. Rycerz. “Practical remarks concerning phase diagrams determination on the basis of differential scanning calorimetry measurements.” *JTAC* **113**(1) July, 231–238, 2013.
 14. K. A. Romberger, R. E. Thoma, and J. Braunstein. “New electrochemical measurements of liquidus in LiF-BeF₂ system: Congruency of Li₂BeF₄.” *J. Phys. Chem.* **76**(8), 1154–1159, 1972.
 15. W. Weppner, C. Li-chuan, and W. Piekarczyk. “Electrochemical determination of phase-diagrams and thermodynamic data of multicomponent systems.” *Zeitschrift Fur Naturforschung Section A-A, J. Phys. Sci.* **35**(4), 381–388, 1980.
 16. H. A. Friedman, G. M. Hebert, and R. E. Thoma. *Thermal Analysis And Gradient Quenching Apparatus And Techniques for The Investigation of Fused Salt Phase Equilibria*, ORNL-3373, Oak Ridge National Laboratory, 1963. <https://www.osti.gov/scitech/biblio/4726793>
 17. J. P. M. van der Meer, R. J. M. Konings, K. Hack, and H. A. J. Oonk. “Modeling and calculation of the LiF-NaF-MF₃ (M = La, Ce, Pu) phase diagrams.” *Chem. Mater.* **18**(2), 510–517, January 24, 2006.
 18. S. Cantor, J. W. Cooke, A. S. Dworkin, G. D. Robbins, R. E. Thoma, and G. M. Watson. *Physical Properties of Molten-Salt Reactor Fuel, Coolant, and Flush Salts*, ORNL-TM-2316, Oak Ridge National Laboratory, August 1968.
 19. G. J. Janz, G. L. Gardner, U. Krebs, and R. P. T. Tomkins. “Molten salts: Volume 4, Part 1, Fluorides and mixtures electrical conductance, density, viscosity, and surface tension data.” *J. Phys. Chem. Ref. Data* **3**, 1–115, 1974.
 20. M. Franko and C. D. Tran. “Thermal lens spectroscopy,” in *Encyclopedia of Analytical Chemistry*, ed. R. A. Meyers, John Wiley and Sons Ltd., 2010, 1249–1279.
 21. E. S. Chaleff, T. Blue, and P. Sabharwall. “Radiation heat transfer in the molten salt FLiNaK.” *Nucl. Technol.* **196**(1), 53–60, 2016.
 22. S. Su, T. Villalon Jr., U. Pal, and A. Powell. “Techniques for measuring solubility and electrical conductivity. Advances in molten slags, fluxes, and salts,” pp. 465–475 in *Proceedings of The 10th International Conference on Molten Slags, Fluxes and Salts (MOLTEN16)*, ed. R. G. Reddy, P. Chaubal, P. C. Pistorius, and U. Pal. TMS (The Minerals, Metals and Materials Society), 2016.
 23. T. Villalón Jr., S. Su, and U. Pal. “Surface properties of molten fluoride-based salts: Advances in molten slags, fluxes, and salts,” pp. 597–605 in *Proceedings of the 10th International Conference on Molten Slags, Fluxes and Salts (MOLTEN16)*, ed. R. G. Reddy, P. Chaubal, P. C. Pistorius, and U. Pal. TMS (The Minerals, Metals & Materials Society), 2016.

24. U. Pal, S. Su, and T. Villalon. "Molten flux design for solid oxide membrane-based electrolysis of aluminum from alumina," in *Applications of Process Engineering Principles in Materials Processing, Energy and Environmental Technologies*, ed. M. L. Free, S. Alam, M. Zhang, and P. R. Taylor. The Minerals, Metals, & Materials Series. ISBN: 978-3-319-51090-3 (print), 978-3-319-51091-0 (online).
25. K. A. Sense, C. A. Alexander, R. E. Bowman, and R. B. Filbert Jr. "Vapor pressure and derived information of the sodium fluoride-zirconium fluoride system: Description of a method for the determination of molecular complexes present in the vapor phase." *J. Phys. Chem.* **61**(3), 337–344, 1957.
26. T. Lichtenstein, N. D. Smith, J. Gesualdi, K. Kumar, and H. Kim. "Thermodynamic properties of barium-bismuth alloys determined by EMF measurements." *Electrochim. Acta* **228**, 628–635, 2017.
27. B. Jabes, M. Agarwal, and C. Chakravarty. "Structure and transport properties of LiF-BeF₂ mixtures: Comparison of rigid and polarizable ion potentials." *J. Chem. Sci.* **124**, 261–269, 2012; L. C. Dewan, C. Simon, P. A. Madden, L. W. Hobbs, and M. Salanne. "Molecular dynamics simulation of the thermodynamic and transport properties of the molten salt fast reactor fuel LiF-ThF₄." *J. Nucl. Mater.* **434**(1–3), 322–327, 2013; H. Luo, S. Xiao, S. Wang, P. Huai, H. Deng, and W. Hu. "Molecular dynamics simulation of diffusion and viscosity of liquid lithium fluoride." *Comp. Mater. Sci.* **111**, 203–208, 2016; M. Matsumiya and R. A. Takagi. "Molecular dynamics simulation of the electric properties in molten chloride and fluoride quaternary systems." *Electrochim. Acta*, **46**(23), 3563–3572, 2001; H. O. Nam, A. Bengtson, K. Vörtler, S. Saha, R. Sakidja, and D. Morgan. "First-principles molecular dynamics modeling of the molten fluoride salt with Cr solute." *J. Nucl. Mater.* **449**(1–3), 148–157, 2014; M. Salanne, C. Simon, P. Turq, N. Ohtori, and P. A. Madden. "Modeling of molten salts," in ed. F. Lantelme and H. Groult, *Molten Salts Chemistry*. Elsevier, Oxford, 1–16, 2013; M. Salanne, C. Simon, P. Turq, and P. A. Madden. "Simulation of the liquid–vapor interface of molten LiBeF₃." *Comptes Rendus Chimie* **10**(10–11), 1131–1136, 2007; M. Salanne, C. Simon, P. Turq, and P. A. Madden. "Heat-transport properties of molten fluorides: Determination from first-principles." *J. Fluorine Chem.* **130**(1), 38–44, 2009; J. Wang, J. Wu, G. Lu, and J. Yu, "Molecular dynamics study of the transport properties and local structures of molten alkali metal chlorides. Part III: Four binary systems: LiCl-RbCl, LiCl-CsCl, NaCl-RbCl, and NaCl-CsCl." *J. Mol. Liq.* **238**, 236–247, July 2017, doi.org/10.1016/j.molliq.2017.03.103; S. Wang, H. Luo, H. Deng, S. Xiao, and W. Hu. "A molecular dynamics study of the transport properties of LiF-BeF₂-ThF₄ molten salt." *J. Mol. Liq.* **234**, 220–226, 2017.
28. A. Bengtson, H. O Nam, S. Saha, R. Sakidja, and D. Morgan. "First-principles molecular dynamics modeling of the LiCl-KCl molten salt system." *Comp. Mat. Sci.* **83**, 362–370, 2014; J. Song, S. Shi, X. Li, and L. Yan. "First-principles molecular dynamics modeling of UCl₃ in LiCl-KCl eutectic." *J. Mol. Liq.* **234**, 279–286, 2017.
29. S. M. Kathmann, G. K. Schenter, B. C. Garrett, B. Chen, and J. I. Siepmann. "Thermodynamics and kinetics of nanoclusters controlling gas-to-particle nucleation." *J. Phys. Chem. C* **113**(24), 10354–10370, 2009; L. D. Crosby, S. M. Kathmann, and T. L. Windus. "Implementation of dynamical nucleation theory with quantum potentials." *J. Comput. Chem.* **30**(5), 743–749, 2009; S. M. Kathmann, G. K. Schenter, and B. C. Garrett. "The critical role of anharmonicity in aqueous ionic clusters relevant to nucleation." *J. Phys. Chem. C* **111**(13), 4977–4983, 2007; S. M. Kathmann. "Understanding the chemical physics of nucleation." *Theor. Chem. Accounts* **116**(1–3), 169–182, 2006.
30. A. Di Cicco, A. Minicucci, and A. Filippini. "New advances in the study of local structure of molten binary salts." *Phys. Rev. Lett.* **78**, 460–463, 1997; A. Minicucci, and A. Di Cicco. "Short range

- structure in solid and liquid CuBr probed by multiple-edge x-ray absorption spectroscopy.” *Phys. Rev. B*, **56**, 11456–11464, 1997; A. Di Cicco. “Local structure in binary liquids probed by EXAFS.” *J. Phys. Condens. Matter*, **8**, 9341–9345, 1996; A. Trapanati, A. Di Cicco, and M. Minicucci. “Structural disorder in liquid and solid CuI at high temperature probed by x-ray absorption spectroscopy.” *Phys. Rev. B*, **66**, 014202, 2002; M. Inui, S. Takeda, K. Maruyama, Y. Shirakawa, and S. Tamaki. “XAFS measurements on molten silver-halides.” *J. Non-Cryst. Solids*, **192–193**, 351–354, 1995; S. Takeda, Y. Kawakita, M. Inui, and K. Maruyama. “Local structure on molten $\text{Ag}(\text{Cl}_{1-x}\text{I}_x)$ mixtures.” *J. Non-Cryst. Solids*, **250–252**, 410–414, 1999.
31. J. J. P. Stewart. “Optimization of parameters for semiempirical methods V: Modification of NDDO approximations and application to 70 elements.” *J. Mol. Model.* **13**, 1173–1213, 2007.
32. D. Feller, K. A. Peterson, and D. A. Dixon. “The impact of larger basis sets and explicitly correlated coupled cluster theory on the Feller-Peterson-Dixon composite method,” in *Annu. Rep. Comput. Chem.*, vol. 12, ed. D. A. Dixon, Elsevier, Amsterdam, 2016, 47–78; K. S. Thanthiriwatte, M. Vasiliu, S. R. Battey, Q. Lu, K. A. Peterson, L. Andrews, and D. A. Dixon. “Gas phase properties of MX_2 and MX_4 ($\text{X}=\text{F}, \text{Cl}$) for $\text{M} = \text{group 4, group 14, Ce, and Th}$.” *J. Phys. Chem. A*, **119**, 5790–5803, 2015; M. Vasiliu, S. Li, D. Feller, J. L. Gole, and D. A. Dixon. “Structures and heats of formation of simple alkaline earth metal compounds: Fluorides, chlorides, oxides, and hydroxides for Be, Mg, and Ca.” *J. Phys. Chem. A* **114**, 9349–9358, 2010; K. O. Christe, R. Haiges, M. Vasiliu, and D. A. Dixon. “Formation mechanism of NF_4^+ salts and extraordinary enhancement of the oxidizing power of fluorine by strong Lewis acids.” *Angew. Chem., Int., Ed.*, accepted April 2017; M. Chen, T. P. Straatsma, Z. Fang, and D. A. Dixon. “A structural and electronic property study of $(\text{ZnO})_n$, $n \leq 168$: The transition from zinc oxide molecular clusters to ultra-small nanoparticles.” *J. Phys. Chem. C* **120**, 20400–20418, 2016.
33. T. P. Straatsma, E. J. Bylaska, H. J. J. van Dam, N. Govind, W. A. de Jong, K. Kowalski, and M. Valiev. “Advances in scalable computational chemistry: NWChem.” *Annu. Rep. Comput. Chem.* **7**, 151–177, 2011; T. P. Straatsma and D. G. Chavarría-Miranda. “On eliminating synchronous communication in molecular dynamics simulation to improve scalability.” *Comput. Phys. Commun.* **84**, 2634–2640, 2013; D. G. Chavarría-Miranda, K. Agarwal, and T. P. Straatsma. “Scalable PGAS metadata management on extreme scale systems,” pp.103–111 in *Proceedings of the 13th IEEE/ACM International Symposium on Cluster, Cloud and Grid Computing (CCGrid)*. Delft, the Netherlands, May 2013.; H. J. J. van Dam, W. A. de Jong, E. J. Bylaska, N. Govind, K. Kowalski, T. P. Straatsma, and M. Valiev. “NWChem: Scalable parallel computational chemistry.” *Comput. Mol. Sci.*, Wiley Interdisciplinary Reviews, **1**(6), 888–894, 2011.

3. FRD 2: Understanding the Structure, Dynamics, and Chemical Properties of Molten Salts

3.1 Background and Current Status

The structural and dynamical properties of molten salt systems have been investigated at varying levels of detail over the past five decades, resulting in established techniques amenable to the characterization and interrogation of MSR-relevant salts. Methods that have great utility include ultraviolet-visible-infrared (UV-vis-IR) spectroscopy, x-ray absorption spectroscopy (XAS), Raman spectroscopy, and nuclear magnetic resonance (NMR) spectroscopy. These methods provide information on (1) oxidation states of transition metals, lanthanides, and actinides and (2) local structure and bonding of species in solution. Complementary methods that apply to crystallized salts and salt mixtures in both the solid and liquid states include XRD, neutron diffraction, and x-ray absorption fine structure spectroscopy (XAFS), with current instrumentation and sampling methods permitting studies at temperatures of up to 1000 °C or even higher in some cases. Application of these methods yields direct structural information, including inter-atomic distances and coordination numbers. Additional information about cation-anion interactions can be gained from NMR spectroscopy of ions like ${}^7\text{Li}^+$, ${}^{19}\text{F}^-$, ${}^{11}\text{B}$ (in BF_4^-), ${}^{23}\text{Na}^+$, ${}^{27}\text{Al}^{3+}$, selected lanthanides (e.g., ${}^{139}\text{La}^{3+}$) and actinides (e.g., ${}^{235}\text{U}^{3+,4+}$) cations, and other relevant NMR active ions.

An idealized perspective of the structure of a molten salt is conceptualized as a set of cations embedded in a sea of halide anions, typified by the binary salt NaCl. Short-range structural properties are attributable to competition between coulombic interactions and Pauli repulsion, inducing strong ordering effects and determining the closest interatomic distances, respectively. A corollary resulting from the influence of these contrasting phenomena is that the innermost coordination shell will always be completely made up of oppositely charged species, affording an intermediate-scale ordering that extends to several solvation shells. [1] Such conclusions were validated by neutron scattering measurements performed on molten NaCl for three different isotopic compositions of Cl⁻, shown in Figure 11. (Note the difference in the structure factor profile as a function of isotope.) The key finding here is that no evidence exists for covalency or effects associated with polarization (consistent with the fact that molten NaCl does not exhibit a Raman spectrum). The coordination number for unlike ions (first coordination shell) was determined to be 5.8 ± 0.1 and the coordination number for like atoms (second shell) was found to be 13.0 ± 0.5 ; both quantities are consistent with values for their solid-state counterparts, i.e., in this simplest case, the melt is close to isostructural with the solid.

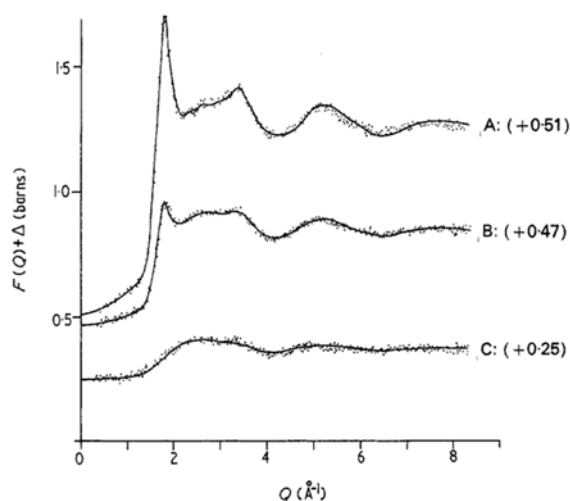

Figure 11. Total structure factor, $F(Q)$, data for liquid Na^{35}Cl (curve A), NaCl (Curve B), and Na^{37}Cl (Curve C) at 875 °C. The points are the experimental data and the curves are derived from the partial structure factors | Reproduced from F. G. Edwards, J. E. Enderby, R. A. Howe, and D. A. Page. "The structure of molten sodium chloride." *J. Phys. C: Solid State Phys.* 8(21), 3483–3490, 1975, <http://iopscience.iop.org/article/10.1088/0022-3719/8/21/018/pdf>

However, introduction of any complexity beyond the aforementioned idealized system, such as substitution of a divalent cation for a monovalent Na^+ , results in structural effects that remain difficult to understand and fully rationalize. While the identity of the inner sphere coordinating atoms remains as anticipated, variation of the inner-sphere cation-anion bond lengths is observed, and different outer sphere

cationic species arise from the interplay of multiple atomic interactions. Polarization-induced intermediate structure can also occur, resulting in edge-sharing of the first-neighbor coordination shell. Such phenomena are further influenced by the energy of the outer shell of the atoms, with formation dependent upon the concentration of the salt and the number of cations present in the outer sphere. For example, the structure of a ZnCl_2 melt was characterized by neutron diffraction and XRD, revealing a tetrahedral first-shell coordination environment for Zn^{2+} , where corner sharing of adjacent octahedrals resulted in intermediate ordering. [2] For atomistic simulations to reasonably represent this system, unrealistically large dispersion interactions were required among the cations, [3] which were reconciled by the introduction of a component representing polarization of the ionic electron cloud. [4]

It has also been demonstrated that for composite salts, the melt does not rearrange into a simple combination of component parts. For example, XAFS spectroscopy was used to investigate the melting of Rb_2ZnCl_4 [5] in comparison with the liquid structure of ZnCl_2 and RbCl . While molten ZnCl_2 displayed tetrahedrally-coordinated corner-sharing chlorines, forming the extended network discussed above, RbCl displayed significant distortion of the chloride shell around Rb , indicative of significant movement of Rb^+ and Cl^- in the molten state. [6] However, in molten Rb_2ZnCl_4 , isolated $[\text{ZnCl}_4]^{2-}$ units were identified with a chlorine coordination of 7.6 around Rb^+ , in contrast to a chlorine coordination of 4.8 in molten RbCl . Thus, the salt structure formed by their combination does not afford the same metal coordination environment for Rb^+ and Zn^{2+} as in RbCl and ZnCl_2 , respectively.

In the above example, the room-temperature solid state structure of Rb_2ZnCl_4 was similar to that in the molten form; however, this is not universally true. In other instances, atomic rearrangement occurs, so that the molten structure differs dramatically from that of the solid precursor. For example, Crozier and colleagues investigated the liquid structures of $[\text{Bu}_4\text{N}][\text{MnBr}_3]$ and $[\text{Bu}_4\text{N}]_2[\text{MnBr}_4]$, identifying a bromine coordination number of 3.1 around manganese in the liquid state, compared with a coordination number of 6 in the solid-state structure. [7] Molten PbCl_2 has also shown a change in local coordination environment upon melting, with a decrease in chlorine ligation from nine to six. [8]

Studies of lanthanide halides have also revealed unanticipated structural changes. Upon melting, LaCl_3 displays a first shell coordination number suggesting an equal mixture of $[\text{LaCl}_7]^{4-}$ and $[\text{LaCl}_8]^{5-}$. A decrease in the La^{3+} - Cl^- bond length has also been observed, contrary to what would be anticipated at elevated temperatures. [9] Insight into the latter comes from work performed on an AgBr salt. It revealed a similar first-shell bond length contraction upon melting, while radial distribution functions of atomic positions revealed greater asymmetry toward longer distances and indicated the average bond length to be increasing, as is expected from thermal expansion. [10] Such behavior suggests in both instances the metal is more appropriately conceptualized as forming MCl_x molecules with the anion than as isolated M^{x+} dissolved in a Cl^- solvent. Proceeding down the periodic group revealed significant structural differences in YCl_3 compared with LaCl_3 . The $\text{Y}^{3+} - \text{Y}^{3+}$ distance was 0.25 Å closer than the analogous $\text{La}^{3+} - \text{La}^{3+}$, which was attributed to different linkages in the different salt. Whereas LaCl_3 displays corner-sharing six-fold complexes, YCl_3 is proposed to have edge-sharing complexes. [11] Thus, structural properties can vary dramatically based on the species of the cation, which has been previously demonstrated to significantly influence chemical properties, such as solubility of actinide complexes. [12]

While molten salts are regarded as purely ionic solutions, the formation of MCl_x species upon melting, as discussed above, suggests covalent interactions are also a significant, albeit unanticipated, possibility. Further work was performed by Okamoto and colleagues in which YCl_3 and YBr_3 were dissolved in a LiCl-KCl eutectic with LiBr , respectively. Investigation of the extended XAFS spectrum of Y revealed a sharpening of the first major feature and a small decrease in bond length. These results are consistent with improved stabilization of a YX_3 molecular complex upon further dilution with the alkali salt. [13] Copper and silver halides have also been shown to display significant covalent behavior. Work by Di Cicco and colleagues indicates nearly total covalent bonding observed in solid CuBr , which is similar to what is

observed in the liquid state. A quasi-continuous phase change occurred during melting, which afforded a significant decrease in Cu-Br bond length in the liquid compared with the solid. [14] A similar structure for liquid CuI was also determined, supporting the same conclusion. [15] Studies of AgCl-AgI mixtures reveal silver coordination environments composed of two chloride and two iodide atoms at temperatures below the melting point; but upon melting, the chloride contribution decreased significantly while the iodide was invariant. This decrease is thought to have occurred as a result of the removal of chloride atoms from the first coordination shell as the bonding strength between silver and iodide increases. [16]

Chemical bond lengths are representative of bond strengths, indicative in turn of the chemical reactivity of the molten salt. This is clearly demonstrated by Cho et al., who investigated the covalency of uranium(III) and uranium(IV) chlorides and observed that as the U-Cl distance became shorter, the interactions became stronger and the reactivity decreased. [17] As noted above, the molecular structure of the melt is known to influence the solubility and chemical reactivity of the constituents. Accordingly, detailed structural knowledge of molten salts is essential for understanding and predicting the chemical behavior in a MSR, not only to determine bulk physicochemical properties but also to understand the solubility and behavior of fission, activation, and corrosion products present in the melt.

In addition to the majority constituents in the starting salt, it is necessary to investigate, identify, understand, and predict the multi-faceted behaviors of the accumulating fission products. There are numerous examples in the literature of spectroscopic and diffraction studies that are directly applicable to this research direction; and the behavior of the “sometimes soluble” niobium, tellurium, and insoluble noble metal fission products (elements between niobium and tellurium) are particularly important. For example, Toth et al. measured the UV-vis-IR absorption spectrum of telluride species in molten Li_2BeF_4 . Their work showed that although Te^{2-} was not detectable in Li_2BeF_4 by optical absorption spectroscopy, when the Te^{2-} ion was mixed with metallic tellurium, a soluble poly-telluride species formed that could be detected in the absorption spectrum of the molten salt solution [18] (Figure 12a). This study provides insight into the solvation properties that could affect tellurium migration in an MSR coolant salt system.

In light of the preference for using low-enrichment fissile constituents, very high actinide salt concentrations are needed, affording salts with very different chemical properties and coordination chemistry from dilute actinide-containing solutions. For example, the Raman spectrum of molten LiF-NaF-ThF_4 at 650 °C shown in Figure 12b sheds light on the coordination behavior of Th^{4+} in molten fluorides. Eight-coordinated Th^{4+} was identified in melts with excess fluoride ions by comparing their spectra with that of crystalline K_5ThF_9 . The existence of seven-coordinated Th^{4+} , present in fluoride-ion-deficient melts, was identified by shifts in the frequency of the 474 cm^{-1} band with changes in melt composition. This represents a case in which the coordination chemistry of an actinide cation is affected by solvent composition.

High-temperature solid state and liquid NMR can provide insights into the local structure of species in the melt and interactions of the cation-anion. For example, in the high-temperature ^{19}F NMR spectra for solid and molten $\text{YF}_3\text{-LiF}$ (Figure 13), there is a substantial down field shift in the ^{19}F resonance with increasing LiF content. This large shift indicates that the nature of the interaction between F^- anions and Y^{3+} cations is influenced by the amount of Y^{3+} in the melt. The higher the quantity of Y^{3+} , the more bridging the F^- ions become. The differences in line width for the solid and the liquid state are due to differences in relaxation times. Note also in Figure 13 that the ^{19}F NMR resonance pattern of the solid shows a significant difference from that of the liquid with increasing YF_3 content. One interpretation of this observation is that there are multiple F^- site types in the solid that are randomized by the ionic mobility in the liquid state.

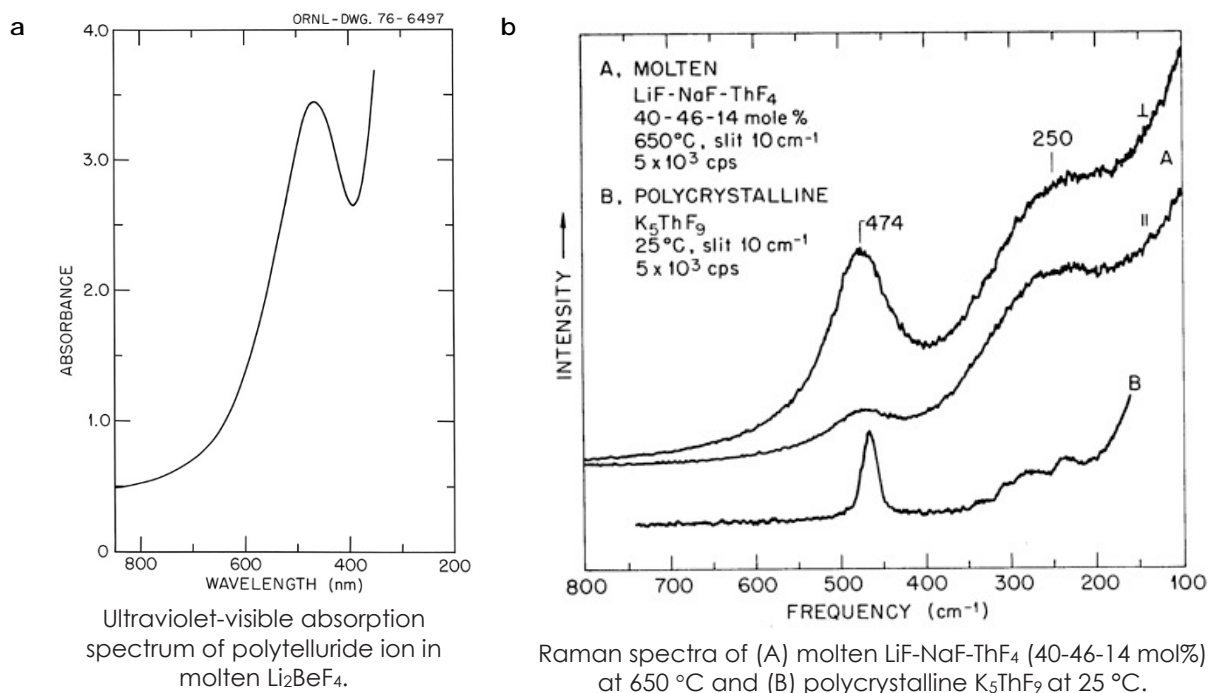

Figure 12. (a) Ultraviolet-visible and (b) Raman spectroscopy results reveal species identity in molten salts. | Images courtesy of Oak Ridge National Laboratory.

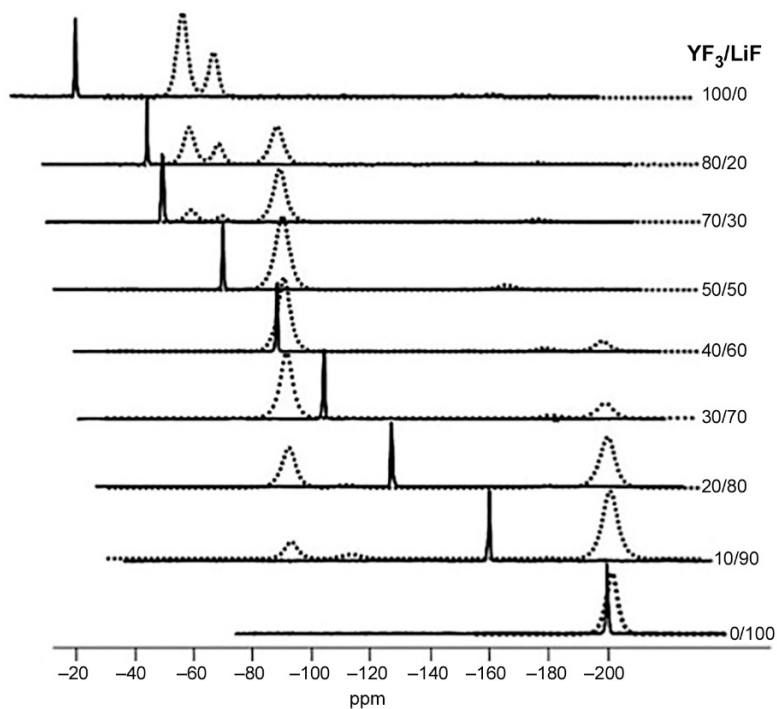

Figure 13. High temperature ^{19}F NMR spectra of $\text{YF}_3\text{-LiF}$ as a function of composition. Black lines are for the molten state; dotted lines are for the solid state at temperatures 700–1100 °C (estimated). | Reproduced from Anne-Laure Rollet et al. "In situ high temperature NMR and EXAFS measurements in rare-earth fluoride molten salts," *Comptes Rendus Chimie* 2004 7(12), 1135–1140. 2004.

Elsevier Masson SAS. All rights reserved.

In similar measurements for the $\text{LaF}_3\text{-LiF}$ system, the corresponding ^{139}La NMR spectra showed that the first coordination shell around the La^{3+} cations changed very little with composition. [19] The radial structure functions derived from analysis of the extended XAFS (EXAFS) spectra in Figure 14 support the ^{139}La NMR results for the first coordination shell, but they give evidence of significant differences in coordination environment beyond the first shell when the solid and molten states are compared.

The results in Figures 11 through 14 provide excellent examples of how the proposed measurement methods provide the information needed regarding oxidation states, coordination numbers, inter-ion spacing, local and long-range order, and solvation that will be used to elucidate the structure and dynamics of MSR-relevant molten salt systems.

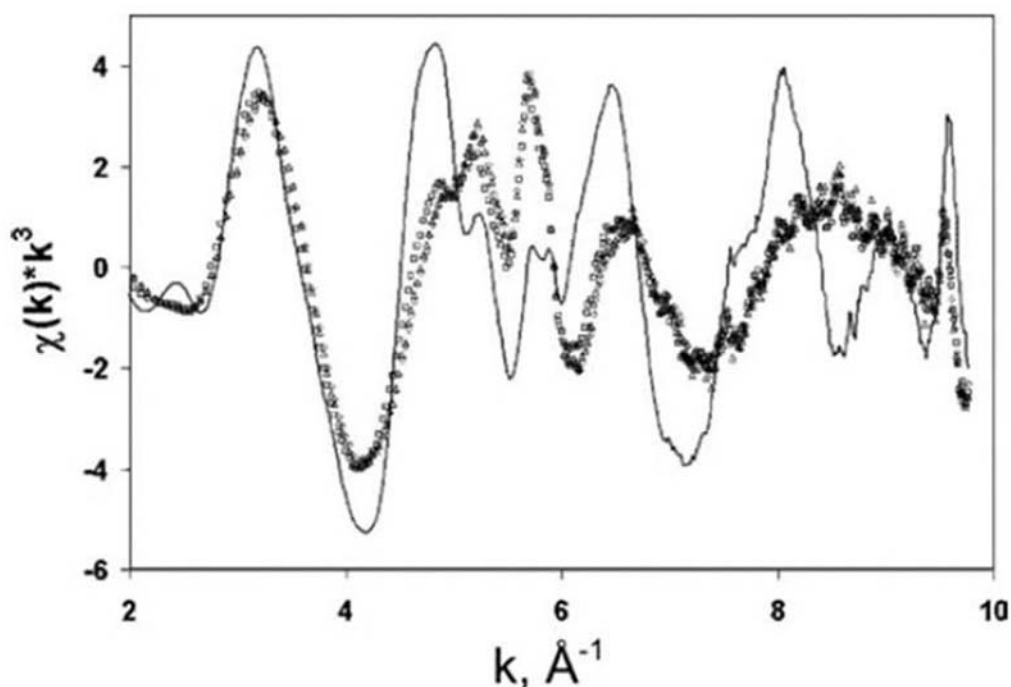

Figure 14. La LIII EXAFS spectra of molten $\text{LaF}_3\text{-LiF}$ (20-80 mole%): (a) solid phase (solid line), (b) melt at 780 °C (open triangles), and (c) melt at 850 °C (open diamonds). | A.-L. Rollet, "Local structure analogy of lanthanide fluoride molten salts." *International Journal of Thermophysics*, Vol. 26(4), 1115–1125, 2005. Used with permission of Springer.

Dissolved species in molten salts exist as highly mobile metal complexes, whereas insoluble and semi-soluble elements may exist as suspended fine particles (metallic or salt precipitates) or as surface deposits on the wetted materials. In both instances, the insoluble species exist in dynamic equilibrium with the dissolved species and temperature, concentration, speciation, and other factors impact this equilibrium. At the concentrations required for soluble and semi-soluble elements to appear in the salt, the short-range structure of the salt (complexation between cations and anions) is sufficiently affected to impact a broad range of thermophysical properties, such as viscosity, diffusion and transport coefficients (thermal or concentration gradient induced migration), and chemical activity (the propensity of a particular phase to

be stable or instable). These changes in physicochemical behavior dramatically affect critical engineering factors, such as corrosion behavior and thermal conductivity.

Design and development of a fully functional MSR that meets all the requirements for sustained operation, including materials compatibility, manageable radionuclide containment and disposition, and tenable economics will require detailed knowledge of the structure and chemical speciation of complex ions and other associated species in the molten salt system, as well as real-time monitoring of the species in solution. The net oxidation/reduction condition of the salt must be tracked and understood as a function of burnup, and the time evolution (dynamics) of molten salt structure and elemental speciation as a function of burnup must be fully elucidated on the local and global scales. The influence of these structural and dynamical behaviors on other thermophysical and transport properties must be measured and reconciled.

3.2 Technical Challenges and Research Directions

To understand how the structure and dynamics of molten salts impact their physical and chemical properties—such as viscosity, solubility, volatility, and thermal conductivity—it is necessary to determine the structure and speciation of the molten salt using advanced spectroscopic and scattering methods that provide information at the atomic/molecular scale. Where necessary, innovative experimental methods for microscopic and macroscopic property measurements will be employed, with emphasis on high-throughput techniques (i.e., ones applicable to radionuclides) to accommodate the efficient gathering of data for the large information base expected to be needed to underpin/support MSR design and development. *Real-time analysis methods need to be developed for monitoring key chemical species in solution, allowing optimization of reactor performance and lifetime.* This experimental work must be closely interfaced with first-principles computational and data analysis approaches to establish validated predictive models for system performance.

3.2.1 Determining Molecular Structure by X-ray and Neutron Scattering and Spectroscopy

In the nearly five decades following the decommissioning of ORNL's MSRE, astounding gains have been made in the development of advanced x-ray and neutron scattering and spectroscopy techniques, which will enable precise investigation of the structure of molten salts and the coordinate environment of the actinides and fission products. Third-generation synchrotron light sources typically have brilliance in excess of 10^{18} photons s^{-1} with exquisite polarization, collimation, energy tunability, and low emittance, enabling real-time analysis with high-energy techniques that were not possible during the MSRE. Similarly, access to high-flux neutron scattering facilities now allows the investigation of structures, coordination environments, and buried structural features and dynamics at high temperatures; and additional information can be gained by leveraging isotopic contrast.

Development of robust methodologies and high-temperature sample cells (up to 850 °C) is essential for the application of such techniques to the investigation of molten salt structure at operational temperatures to enhance the understanding of fundamental salt properties in the bulk. The application of XAFS (see the sidebar "XAFS of Molten Salts" on p. 29) to the molten salts relevant to a MSR has been limited, yet it provides an avenue for investigating the local atomic structures of melt constituents. It is also a potential means of identifying fission and corrosion product oxidation states and geometries, particularly in instances where dilute elemental concentrations prohibit the application of other techniques.

Application of soft x-rays, suitable for XAFS of light elements (before scandium in the periodic table, with specific MSR-relevance including Na, Mg, and Al), may afford important structural information for the salts in the melt phase. A significant challenge is the design of sample holders capable of preserving an air- and moisture-free environment at MSR operational temperatures (up to and exceeding 850 °C)

while sufficiently enclosing the low-viscosity melt and permitting sufficient penetration of low-energy x-rays. Another difficulty is the need for sample holders that are amenable to the analysis of low-concentration components in the melt. Data for trace elements are customarily collected with fluorescence detectors, but few instances of such measurements exist in the molten salts literature, none of which involves elevated temperatures or carefully controlled atmospheres. [20]

High energy x-ray or neutron scattering measurement affording the elemental pair distribution function (PDF) is another quantum-beam technique capable of affording otherwise unobtainable insights regarding molecular structure. The PDF is the Fourier transform of the total scattering pattern and affords the probability of finding an atom at a given distance. Investigation of the PDF allows interrogation of bond lengths and crystal structures and is a particularly powerful technique following the subtraction of background scattering (i.e., differential-PDF). [24] Recent work has demonstrated the capability of PDF studies to investigate the exchange kinetics of the first and second coordination environment of aqueous metal halides (see Figure 15), [25, 26] yet extension of such efforts to molten salts is non-trivial. Neutron-PDF investigations afford the opportunity to introduce isotopic contrast (due to different scattering cross sections of the elements), allowing the elucidation of which molecular moieties contribute at a given spatial range. While the inherent opportunity for investigating the structure of materials devoid of long-range ordering is obvious, isotopic contrast nevertheless diminishes with increasing Z-number and is

typically insufficient for elements heavier than phosphorous. Therefore, *the development of approaches by which maximum information can be gained from scattering data possessing minimal contrast remains an area requiring further development.* Finally, it is important to mention that these techniques are just a subset of potential quantum-beam approaches to investigating the structure and dynamics of molten salts, and that the technique used is contingent upon the scientific question to be answered.

Solid-state and liquid NMR can also be used to determine the local structure of species in the melt and the solid and the cation–anion interactions. Although the temperature range of magic-angle spinning (MAS) techniques is limited to about 500 °C by the mechanical strength of the zirconia rotors, high-temperature MAS probes using a rotor encapsulated in a CO₂ laser-absorbing sleeve are now commercially available. They can be used at temperatures above 2000 °C and enable containerless heating and aerodynamic levitation. [27] The measured chemical shift provides information on the local environment around the observed nucleus and depends on the nature and number of neighbors. As seen in Figure 13, the evolution of the high temperature ¹⁹F resonances in YF₃ in varying amounts of LiF (measured at 20 K above the melting point of the binary mixture, 700–1100 °C) signifies a progressive modification of the fluorine environment from free F⁻ in LiF toward YF_x^{3-x}. The high-temperature ¹⁹F and ⁷Li NMR spectra also reveal that the coordination environment of YF₃ in varying amounts of LiF is different between the melt and the fused state. [28] Since the fluoride is shielded less in the melt, the molten salt is more ionic and thus exhibits a different coordination environment. This is not expected to be the case with chlorides, in which the shielding is lower than in fluoride and complex ion formation has been observed. Coupling high-temperature NMR with complementary techniques such as EXAFS and Raman spectroscopy leads to a better description of the local structure of the salt at high temperatures and provides insights into the origin of the physical and chemical properties.

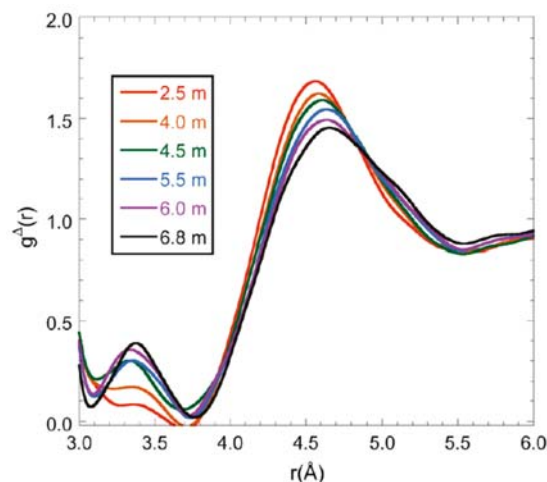

Figure 15. *Differential-PDF measurements were used to investigate the first and second coordination environment of aqueous uranyl as a function of chloride concentration, revealing the formation of inner sphere chloride complexes and reorientation of second sphere solvent molecules upon chloride coordination. The extension of such techniques to investigating the speciation and structure of molten salt components is expected to afford new insights into physical phenomena such as fission product precipitation, corrosion, and gas entrainment.*

[Reprinted with permission from L. Solderholm, S. Skanthakumar, and R. E. Wilson. "Structural correspondence between uranyl chloride complexes in solution and their stability constants." J. Phys. Chem. A 115(19), 4959–4967, 2011. Copyright 2011, American Chemical Society.

3.2.2 Correlating Electrochemistry and Spectroscopy for Online Monitoring and Predictive Modeling

One of the challenges in a MSR is that fission creates an oxidizing chemical environment that can lead to corrosion of the metal walls. For example, when fission of ²³⁵UF₄ occurs, four fluoride ions are released from U⁴⁺ and two fission products are formed—such as ⁹²Kr and ¹⁴¹Ba²⁺ or ¹⁴⁰Xe and ⁹⁴Sr²⁺—which subsequently decay to more stable isotopes. However, the net oxidation state of the products differ from those of the parent actinide, which leads to free fluoride in the system. To prevent corrosion, online monitoring of the redox properties of the melt is essential to enable real-time analysis of the state of the molten salt media. The approaches used should be capable of determining the total uranium as well as the total fraction of uranium in each oxidation state to maintain proper redox chemistry. A mixed-valance

uranium fuel in a halide salt is the starting point, but the ratio of the oxidation states of U^{3+}/U^{4+} will change over the course of the fuel lifetime. Direct monitoring of the fission product buildup is required to determine the optimum time for fission product removal/molten salt replenishing. Also, monitoring for trace impurities or corrosion products will enable feedback on the reactor health.

Spectroscopic monitoring of the molten salts system can simultaneously provide information on the dissolved concentration and oxidation state of optically active species, and on the identity of the dissolved specie as a complex ion. The measurement of U [29–31], Np [32, 33], and Pu [34–36] by absorption spectroscopy in molten salt solutions has been extensively studied since as early as the 1960s. The absorption spectra of the various oxidation states of U, Pu, and Np in molten salt media are quite distinct (as they are in aqueous solution) and have been used as the basis for quantitative measurement. Measurement of U, Np, and Pu species in molten salt solutions has also been achieved by electrochemical methods (see review article by Zhang [37] and references therein). The strength of the electrochemical methods includes durability in strong radiation fields and high operating temperatures. The combination of electrochemical methods with spectroscopic measurements, in conjunction with chemometric modeling techniques, would prove a powerful analytical tool for real-time monitoring. For example, Figure 16a presents absorption spectra for the interconversion between U(III) and U(IV) by electrochemical modulation. [30] The spectroelectrochemical interconversion of Np(IV) to Np(III) is shown in Figure 16b. [32]

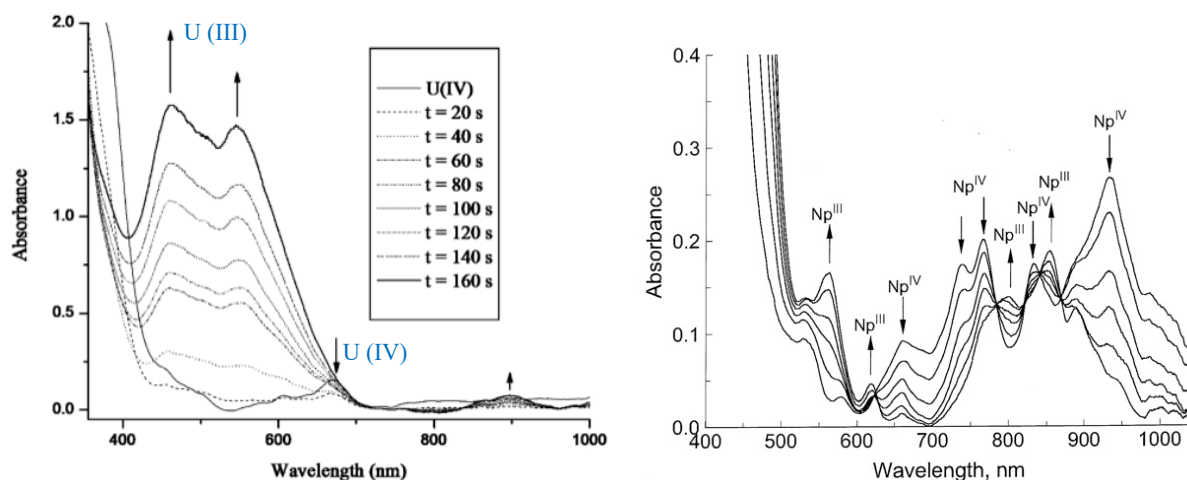

Figure 16. (Left, a) UV-vis absorption spectra following the reduction of U(IV) to U(III) within an alkali chloride molten salt. Reprinted with permission from I. B. Polovov, V. A. Volkovich, J. M. Charnock, et al. *In situ spectroscopy and spectroelectrochemistry of uranium in high-temperature alkali chloride molten salts.* *Inorganic Chemistry* 47(17), 7474–7482, 2008. Copyright 2008, American Chemical Society. (Right, b) The spectroelectrochemical UV-vis measurement of the conversion of Np(VI) to Np(II) in molten LiCl-KCl eutectic media | Reprinted from I. B. Polovov, C. A. Sharrad, L. May, V. A. Volkovich, and B. D. Vasin. *“Spectroelectrochemical study of neptunium in molten LiCl-KCl eutectic.”* *Z Naturforsch A* 62(12), 745–748, 2007.

Spectroscopic measurements, [38] electrochemical measurements, [39] and combined spectro-electrochemical [39, 40] methods have been demonstrated in alkali-halide eutectic solutions containing a mixture of lanthanide chlorides. These techniques enable the quantitative analysis of mixtures of metal salts in molten salt media. [38] As shown in Figure 17, the use of multivariate regression techniques for the quantitative measurement of multiple species with overlapping/interfering absorption bands has been demonstrated. It would be advantageous to apply this approach to several key actinides (U, Np, and Pu). Furthermore, both Raman and UV-vis methods can be incorporated to expand the range of interrogation capabilities.

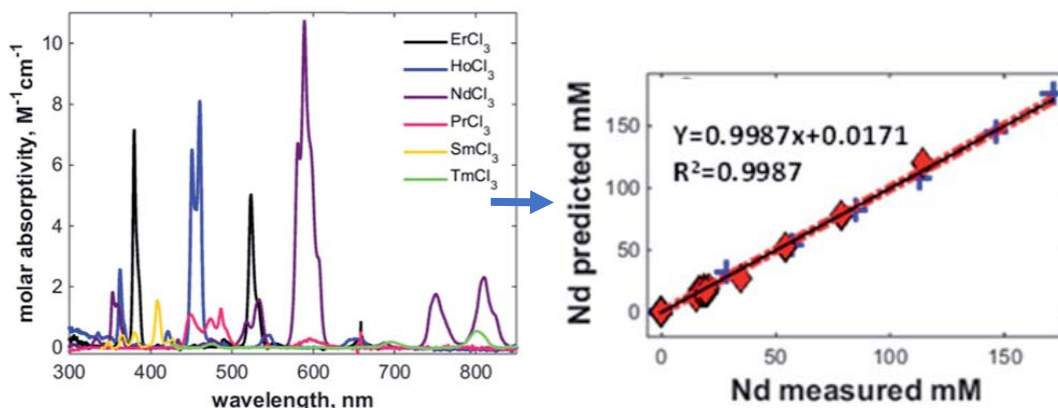

Figure 17. UV-vis absorbance spectra of lanthanides within alkali chloride molten salt (left) and example chemometric modeling results to quantify neodymium within single-component and multicomponent molten salt solutions (right) where training sets data (blue + symbol) were used to build the models that were applied to validation sets (red triangles); a 1:1 correlation (black line) is bounded by the 95% confidence intervals (red dashed lines). [Reproduced from C. A. Schroll, A. M. Lines, W. R. Heineman, and S. A. Bryan. "Absorption spectroscopy for the quantitative prediction of lanthanide concentrations in the 3LiCl-2CsCl eutectic at 723 K." *Anal. Methods-UK* 8(43), 7731–7738, 2016, with permission of the Royal Society of Chemistry.

In addition to redox state, the Lewis acid-base properties of the melt are important in determining the solubility of the actinides in the melt and the corrosivity toward structural materials. The solubility of actinides in a molten salt is fundamentally related to the local basicity of the anions surrounding the metal cation. Phenomenological approaches have been employed to investigate the effects of molten-salt compositions on the solubility properties of actinides. [41] No attempts have been made to correlate these observations with a microscopic rationalization of actinide species solubility in molten salts. In other words, a bridge between macroscopic solubility experiments and microscopic local structural properties is lacking. This information gap has prevented the development of predictive models of molten salts with good solubility properties. *Research is needed to uncover the correlation between the solubility of actinides in molten salts and their fundamental spectral fingerprints.*

In the framework of Lewis acid-base theory, a metal ion behaves as a Lewis acid while the anionic network behaves as a Lewis base. The halide anions of a molten salt surrounding the metal ion donate the negative charge, and this donation reduces the positive charge on the metal ion. [42, 43] The greater the negative charge borne by the halide anions, the greater will be the electron donation. If the metal ion can signal (via optical spectroscopy) the extent to which its positive charge changes, then there is the possibility of using it as a probe for the quantitative measurement of the basicity of the corresponding molten salt medium. The basicity scale thus obtained has been called "optical basicity"; it is one of the most fundamental parameters that characterize a specific molten salt, in analogy to the way pH is used to describe properties of aqueous systems. Metal ions such as Tl^+ , Pb^{2+} , and Bi^{3+} have been employed as optical probes to measure the basicity of industrially interesting oxide glasses. As was pointed out earlier, actinide solutes are known to have characteristic UV-vis and near-IR absorption bands resulting from f-f and charge-transfer electronic transitions. Thus, *a new online and accurate optical basicity scale is needed for actinide-containing molten salts that uses optical spectra of actinide ions as direct probes of the basicity of the melt.*

References

1. M. Salanne and P. A. Madden. "Polarization effects in ionic solids and melts." *J. Mol. Phys.* **109**, 2299–2315, 2011.
2. S. Biggin, M. Gay, and J. E. Enderby. "The structures of molten magnesium and manganese (II) chlorides." *J. Phys. C: Solid State Phys* **14**, 3577, 1981; T. Triolo and A. H. Narten. "X-ray diffraction study of molten zinc chloride at 323°C." *J. Chem. Phys.* **74**, 703, 1981; D. A. Allen, R. A. Howe, and N. D. Wood. "Tetrahedral coordination of Zn ions in molten zinc halides." *J. Chem. Phys.* **94**, 5071, 1991; A. Zeidler, P. S. Salmon, R. A. Martin, T. Usuki, P. E. Mason, G. J. Cuello, S. Kohara, and H. E. Fischer. "Structure of liquid and glassy ZnCl₂." *Phys. Rev. B.* **82**, 104208, 2010.
3. L. V. Woodcock, C. A. Angell, and P. Cheeseman. "Molecular dynamics studies of the vitreous state: Simple ionic systems and silica." *J. Chem. Phys.* **65**, 1565, 1976; P. N. Kumta, P. A. Deymier, and S. H. Risbud. "Improved rigid ion model of molten zinc chloride." *Physica B* **153**, 85, 1988.
4. M. Wilson and P. A. Madden. "Polarization effects in ionic systems from first principles." *J. Phys.: Condens. Matter.* **5**, 6833, 1993; M. Wilson and P. A. Madden. "Short- and intermediate-range order in MgCl₂ melts: The importance of anionic polarization." *J. Phys.: Condens. Matter.* **5**, 2687, 1993.
5. H. Li, K. Lu, Z. Wu, and J. Dong. "EXAFS studies of molten ZnCl₂, RbCl, and Rb₂ZnCl₄." *J. Phys. Condens. Matter* **6**, 3629–3640, 1994.
6. K. Lu, H. Li, Z. Wu, J. Dong, and Z. Cheng. "Structural studies of some chloride melts with EXAFS." *Physica B: Condens. Matter* **208–209**, 339–343, 1995.
7. E. D. Crozier, N. Alberding, and B. R. Sundheim. "EXAFS study of bromomanganate ions in molten salt." *J. Chem. Phys.* **79**, 939–943, 1983.
8. M. Ablanov, H. Matsuura, and R. Takagi. "Extended x-ray absorption fine structure spectroscopy study of PbCl₂ molten salt." *Electrochemistry (formerly Denki Kagaku)* **67**(8), 839–842, 1999.
9. M. Inui, K. Maruyama, Y. Shirakawa, S. Takeda, and S. Tamaki. "EXAFS measurements on molten AgBr-AgI mixtures." *J. Non-Cryst. Solids* **205–207**, 155–158, 1996; M. Inui, M. S. Takeda, K. Maruyama, Y. Shirakawa, and S. Tamaki. "XAFS measurement on molten silver halides." *J. Non-Cryst. Solids* **192–193**, 351–354, 1995.
10. A. Di Cicco, M. Taglienti, M. Minicucci, and A. Filipponi. "Short-range structure of solid and liquid AgBr determined by multiple-edge x-ray absorption spectroscopy." *Phys. Rev. B.* **62**, 12001–12013, 2000; A. Di Cicco, and M. Minicucci. "Solid and liquid short-range structure determined by EXAFS multiple-scattering data analysis." *J. Synchrotron Rad.* **6**, 255–257, 1999.
11. Y. Okamoto, H. Shiwaku, T. Yaita, H. Narita, and H. Tanida. "Local structure of molten LaCl₃ by K-absorption edge XAFS." *J. Mol. Struct.* **641**, 71–76, 2002.
12. S. Dai, L. M. Toth, G. D. Del Cul, and D. H. Metcalf. "Solubilities of uranium(IV) dioxide in magnesium chloride, calcium chloride, and aluminum chloride melts: A comparative study." *J. Phys. Chem.* **100**, 220–223, 1996.
13. Y. Okamoto, T. Yaita, and K. Minato. "High-temperature XAFS study of solid and molten SrCl₂." *J. Non-Cryst. Solids.* **333**, 182–186, 2004.
14. A. Di Cicco, M. Minicucci, and A. Filipponi. "New advances in the study of local structure of molten binary salts." *Phys. Rev. Lett.* **78**, 460–463, 1997; M. Minicucci and A. DiCicco. "Short-range structure in solid and liquid CuBr probed by multiple-edge x-ray-absorption spectroscopy." *Phys. Rev. B.* **56**, 11456–11464, 1997; A. Di Cicco. "Local structure in binary liquids probed by EXAFS." *J. Phys. Condens. Matter* **8**, 9341–9345, 1996.

15. A. Trapananti, A. Di Cicco, and M. Minicucci. "Structural disorder in liquid and solid CuI at high temperature probed by x-ray absorption spectroscopy." *Phys Rev B*. **66**, 014202, 2002.
16. S. Takeda, Y. Kawakita, M. Inui, and K. Maruyama. "Local structure of molten $\text{Ag}(\text{Cl}_{1-x}\text{I}_x)$ mixtures." *J. Non-Cryst. Solids* **250–252**, 410–414, 1999.
17. Y. H. Cho, S.-E. Bae, D.-H. Kim, T.-H. Park, J. Y. Kim, K. Song, and Y. W. Yeon. "On the covalency of U(III)-Cl, U(IV)-Cl bonding in a LiCl-KCl eutectic melt at 450 degrees C: Spectroscopic evidences from their 5f-6d and 5f-5f electronic transitions." *Microchem. J.* **122**, 33–38, 2015.
18. L. M. Toth and G. E. Boyd. "Raman spectra of thorium (IV) in fluoride complex ions in fluoride melts." *J. Phys. Chem.* **77**(22), 2654–2657, 1973.
19. A.-L. Rollet, S. Godier, and C. Bessada. "High temperature NMR study of the local structure of molten LaF_3 -AF (A= Li, Na, K, and Rb) mixtures." *Phys. Chem. Chem. Phys.* **10**, 3222–3228, 2008.
20. A. J. Dent, K. R. Seddon, and T. Welton. "The structure of halogenometallate complexes dissolved in both basic and acidic room-temperature halogenoaluminate(III) ionic liquids, as determined by EXAFS." *J. Chem. Soc. Chem. Commun.* **315–316**, 1990; N. J. Williams, J. Dehaut, V. S. Bryantsev, H. Luo, C. W. Abney, and S. Dai. "Selective separation of americium from europium using 2,9-bis(triazine)-1,10-phenanthrolines in ionic liquids: A new twist on an old story." *Chem. Commun.* **53**, 2744–2747, 2017; C. W. Abney, C. Do, H. Luo, J. Wright, L. He, and S. Dai. "Controlling the intermediate structure of an ionic liquid for f-block element separations." *J. Phys. Chem. Lett.* **8**(9), 2049–2054, 2017.
21. J. J. Rehr and R. C. Albers. "Theoretical approaches to x-ray absorption fine structure." *Rev. Mod. Phys.* **72**(3), 621–654, 2000.
22. S. Calvin. *XAFS for Everyone*. CRC Press, Boca Raton, Florida, 2013.
23. C. W. Abney, R. T. Mayes, M. Piechowicz, Z. Lin, V. Bryantsev, G. M. Veith, S. Dai, and W. Lin. "XAFS investigation of polyamidoxime-bound uranyl contests the paradigm from small molecule studies." *Energy Environ. Sci.* **9** (2), 448–453, 2016.
24. K. W. Chapman, P. J. Chupas, and C. J. Kepert. "Selective recovery of dynamic guest structure in a nanoporous Prussian blue through in situ x-ray diffraction: A differential pair distribution function analysis." *J. Am. Chem. Soc.* **127**(32), 11232–11233, 2005.
25. L. Soderholm, S. Skanthakumar, and R. E. Wilson. "Structural correspondence between uranyl chloride complexes in solution and their stability constants." *J. Phys. Chem. A* **115**(19), 4959–4967, 2011.
26. A. Kalaji, S. Skanthakumar, M. G. Kanatzidis, J. F. Mitchell, and L. Soderholm. "Changing hafnium speciation in aqueous sulfate solutions: A high-energy x-ray scattering study." *Inorg. Chem.* **53**(12), 6321–6328, 2014.
27. B. Coté, D. Massiot, F. Taulelle, and J.-P. Coutures. " ^{27}Al NMR spectroscopy of aluminosilicate melts and glasses." *Chem. Geology* **96**, 367–370, 1992; R. Winter, A. Jonbes, R. Shaw-West, M. Wolff, P. Florian, and D. Massiot. "Laser-heated high-temperature NMR: A time-resolution study." *Appl. Magn. Reson.* **32**, 635–646, 2007.
28. A.-L. Rollet, C. Bassada, A. Rakhmatoulline, Y. Auger, P. Melin, M. Gailhanou, and D. Thiaudière. "In situ high temperature NMR and EXAFS experiments in rare-earth fluoride molten salts." *Comptes Rendus Chimie* **7**(12), 1135–1140, 2004.

29. T. Nagai, A. Uehara, T. Fujii, O. Shirai, N. Sato, and H. Yamana. "Redox equilibrium of U^{4+}/U^{3+} in molten NaCl-2CsCl by UV-Vis spectrophotometry and cyclic voltammetry." *J. Nucl. Sci. Technol.* **42**(12), 1025–1031, 2005.
30. I. B. Polovov, V. A. Volkovich, J. M. Charnock, B. Kralj, R. G. Lewin, H. Kinoshita, I. May, and C. A. Sharrad. "In situ spectroscopy and spectroelectrochemistry of uranium in high-temperature alkali chloride molten salts." *Inorg. Chem.* **47**(17), 7474–7482, 2008.
31. T. Fujii, A. Uehara, T. Nagai, T. J. Kim, N. Sato, Y. Sakamura, and H. Yamana. "Electronic absorption spectra of U(IV) in molten LiCl-SrCl₂ and CsCl-SrCl₂." *Electrochemistry* **77**(8), 667–669, 2009.
32. I. B. Polovov, C. A. Sharrad, L. May, V. A. Volkovich, and B. D. Vasin. "Spectroelectrochemical study of neptunium in molten LiCl-KCl eutectic." *Z Naturforsch A* **62**(12), 745–748, 2007.
33. D. H. Kim, T. H. Park, S. E. Bae, N. Lee, J. Y. Kim, Y. H. Cho, J. W. Yeon, and K. Song. "Electrochemical preparation and spectroelectrochemical study of neptunium chloride complexes in LiCl-KCl eutectic melts." *J. Radioanal. Nuclear Chem.* **308**(1), 31–36, 2016.
34. J. L. Swanson. "Plutonyl species in molten chloride salt solutions." *J. Phys. Chem.* **68**(2), 438–439, 1964.
35. T. Nagai, A. Uehara, T. Fujii, O. Shirai, M. Myochin, and H. Yamana. "Redox equilibria of Pu^{4+}/Pu^{3+} and PuO_2^{2+}/Pu^{4+} couples in molten NaCl-CsCl eutectic as measured by absorption spectrophotometry." *Radiochim. Acta* **97**(4–5), 209–212, 2009.
36. O. Shirai, A. Uehara, T. Fujii, H. Yamana, T. Nagai, and M. Myochin. "Absorbance of plutonium in NaCl-2CsCl molten salt mixtures," in *Proceedings of the 4th Workshop on Molten Salts Technology and Computer Simulation*, Tokai, Japan, December 20, 2004, Japan Atomic Energy Research Institute, 2005.
37. J. S. Zhang. "Electrochemistry of actinides and fission products in molten salts: Data review." *J. Nucl. Mater.* **447**(1–3), 271–284, 2014.
38. C. A. Schroll, A. M. Lines, W. R. Heineman, and S. A. Bryan. "Absorption spectroscopy for the quantitative prediction of lanthanide concentrations in the 3LiCl-2CsCl eutectic at 723 K." *Anal. Methods—UK* **8**(43), 7731–7738, 2016.
39. C. A. Schroll, S. Chatterjee, T. G. Levitskaia, W. R. Heineman, and S. A. Bryan. "Electrochemistry and spectroelectrochemistry of europium(III) chloride in 3LiCl-2KCl from 643 to 1123 K." *Anal. Chem.* **85**(20), 9924–9931, 2013.
40. C. A. Schroll, S. Chatterjee, T. Levitskaia, W. R. Heineman, and S. A. Bryan. "Spectroelectrochemistry of $EuCl_3$ in four molten salt eutectics 3LiCl-NaCl, 3LiCl-2KCl, LiCl-RbCl, and 3LiCl-2CsCl at 873 K." *Electroanalysis* **28**(9), 2158–2165, 2016.
41. S. Dai, L. M. Toth, G. D. DelCul, and D. H. Metcalf. "Solubilities of uranium(IV) dioxide in magnesium chloride, calcium chloride, and aluminum chloride melts: A comparative study." *J. Phys. Chem.* **100**(1), 220–223, 1996.
42. J. A. Duffy and M. D. Ingram. "Optical basicity. 4. Influence of electronegativity on Lewis basicity and solvent properties of molten oxyanion salts and glasses." *J. Inorg. Nuclear Chem.* **37**(5), 1203–1206, 1975.
43. J. A. Duffy, and M. D. Ingram. "Establishment of an optical scale for Lewis basicity in inorganic oxyacids, molten salts, and glasses." *J. Am. Chem. Soc.* **93**(24), 6448–6454, 1971.

4. FRD 3: Understanding Fission and Activation Product Chemistry and Radiation Chemistry

4.1 Background and Current Status

Understanding the fate and transport of fission and activation products in MSR is key to monitoring, predicting, and controlling reactor performance and salt properties (Figure 18). Although the decay pathways of fission and activation products are well established and independent of the chemical environment, the chemical and physical properties of these elements and their interactions with their surroundings are different at each step of the decay chain; they are complicated by the fact these elements exhibit distinct chemical behaviors in different salt mixtures and behave differently in different short-decay regimes. The general understanding is far from complete and remains a major scientific and technology challenge associated with the MSR system. *It is essential to understand which fission products remain dissolved in the salt; which ones are volatile; and which ones precipitate on surfaces (and where), which ones are sometimes soluble, and how the fission products change the corrosivity of the melt.* Furthermore, determination of fission product interactions and solubility is necessary for each unique salt system (e.g., fluoride salts vs. chloride salts vs. new salts). To achieve this level of understanding requires knowledge regarding the chemical nature of the fission and activation products—i.e., the chemical species that exist under particular conditions of salt composition, temperature, and redox state—and how they may react or distribute on surfaces in a dynamic environment.

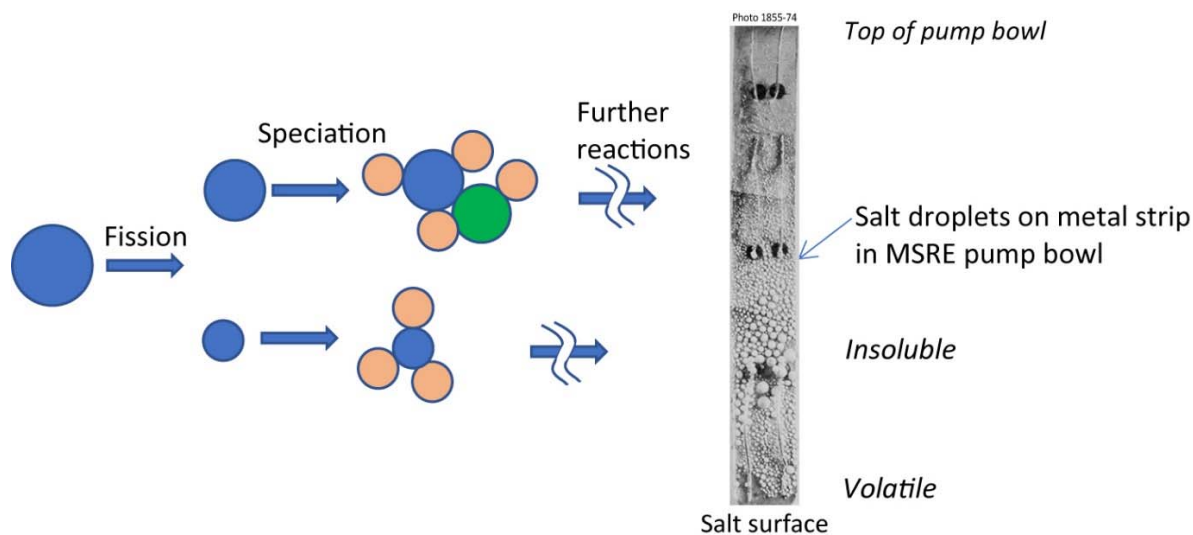

Figure 18. Complex behavior of molten salt and insoluble and volatile fission products. The metal strip was in the MSRE pump bowl gas space; it shows evidence of mist in the gas space and noble metal fission products. | Images courtesy of Oak Ridge National Laboratory

Although fresh fuel salt mixtures have been studied, understanding of transport phenomena, effects of short-term decay, neutron activation, and interfacial interactions are necessary. Individual fuel atoms in the salt undergo fission (see Figure 19), splitting into a few of 40+ elements representing more than 400 different isotopes, while neutron capture generates various transuranic and other activation products (such as ^{36}Cl). Fission liberates large amounts of energy, causing various local disruptions such as ionization or material sputtering. The individual fission product atoms will be highly ionized and will quickly interact with nearby atoms, reaching one of several possible end states dependent on their chemistry and the atoms with which they interact. The interactions with the salt, structural materials, or other fission and

activation products, causes complex speciation. The process is repeated with many variant outcomes for each fission product. The end result can be macroscopically understood based on whether the fission products are soluble, insoluble, volatile, or corrosive. Each of these have implications for the reactor and the physical properties of the salt. On the mesoscale, interactions will be highly dependent on interfacial chemistries between fission products and the materials present. Understanding this and translating it to the macroscale effects, such as corrosion, is necessary.

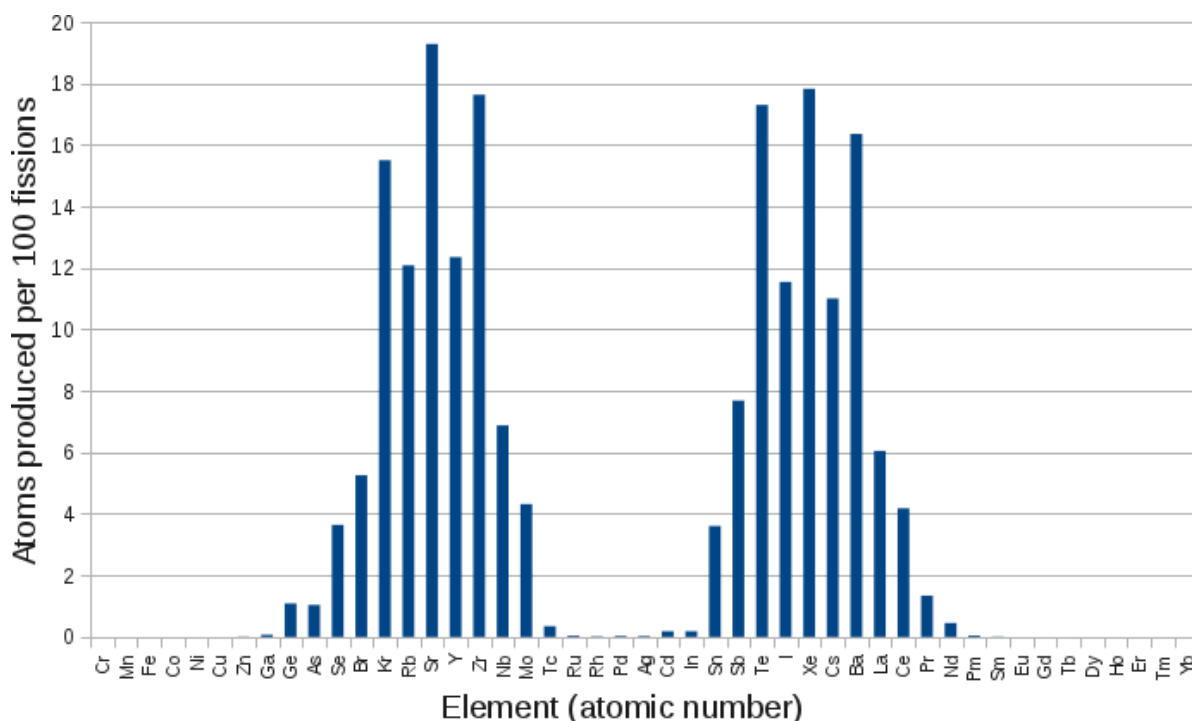

Figure 19. Yields of different elements from fission of ^{235}U . | Image courtesy of Peter Lux. In "Composition of Spent Fuel," Peter Lux Blog, <http://www.plux.co.uk/>. Licensed under a [Creative Commons license Attribution-NonCommercial-ShareAlike 3.0](https://creativecommons.org/licenses/by-nc-sa/3.0/) unported license

At some time after the fission event, the isotopes of the fission products reach chemical equilibrium and behave according to their elemental identities, eventually forming stable species. Soluble species are incorporated within the salt solution and often behave according to their elemental periodic group; insoluble species likely deposit on surfaces, such as the heat exchanger, or at the interface between wetted and non-wetted surfaces; volatile species are driven to the off-gas system; and corrosive species may degrade structural and container materials (Figure 18). To understand the impact of fission products on reactor operation, an understanding the basic physics and chemistry at the atomic, molecular, meso-scale, and continuum length scales, as well as phenomena that occur over a wide range of time scales is required. With full knowledge of the fission product decay pathways and their chemistry, we should be able to design systems that mitigate detrimental effects of fission products with regard to reactor performance and disposition in waste streams.

4.2 Technical Challenges and Research Directions

4.2.1 Understanding the Physical, Chemical, and Radiochemical Properties of the Fission and Activation Products in Molten Salts

As previously discussed, there is a need to understand the chemical bonding and coordination environment (and associated energies) between the solutes (actinides, fission products, and activation products) and the molten salt solvent, since interactions could form out to a length scale that includes

many atoms (in fact, determining the number of atoms that must be included is one of the underlying uncertainties.) Spectroscopic studies (described in Section 3) can provide insights into the coordination environment of the elements, but computational insights would be particularly useful for the more radioactive and short-lived species that are hard to study experimentally. Unfortunately, little theoretical work has been reported on the solvation of individual fission products. Although various computer codes can be used to obtain this information (e.g., the methods described for understanding the solvation of Gd^{3+} dissolved in LiCl and KCl), [1] the more atoms that are involved, the greater the computational expense. Therefore, appropriate assumptions for simplifying the models will need to be developed and validated. In moving from single atoms to complex fission product species, more solute-solvent configurations must be included, as well as an understanding of the internal bonds within the fission product complex. To solve the problem satisfactorily will require combining the results from computer codes that handle atomic- and molecular-scale interactions and properties all the way up to bulk material properties and energetics associated with changes in the physical states of transmuted isotopes.

To understand the binding, solvation, and properties of fission and activation products, a representative set of fission products (several from each of the possible end states, e.g., soluble, insoluble, sometimes soluble, and volatile) that can be both modeled and measured in the laboratory (potentially though the use of nonradioactive surrogates) needs to be investigated. A comparison between experimental and computer models is extremely important, since only validated computational models can be trusted to provide insights into a broader range of fission products and yield meaningful results. This means that the systems that are studied must also possess unique, reliable experimental signatures that extend from single atoms to more complex molecular species.

In addition to out-of-pile chemical studies, in the future, it will be necessary to develop experimental systems with in situ monitoring for the irradiation of salts to probe dynamic fission product chemistry effects and their impact on the physical properties of the molten salt (and reactor operation). With this understanding, we can begin to design systems to mitigate any negative effects associated with fission product transport, localization, or specific radiation/interfacial chemistry. For example, one important result from in-pile studies in the MSRE was the discovery that the fission product tellurium contributed to surface cracking in the alloy Hastelloy N. Tellurium is unusual in that it has a high vapor pressure at the operating temperature of the MSRE, so it can survive as both a dissolved gas and (possibly) as a soluble, reactive ion. [2] To determine the cause of the observed surface cracking, a series of temperature-controlled tests were conducted both to confirm that tellurium was contributing and to subsequently learn how to mitigate its degradation effects. This study showed how a particular fission product's behavior changed with salt redox potential, how it reacted at the interface, and how the negative effect could be mitigated in future designs.

The tellurium study is an example of what needs to be done in greater depth for a range of “salt-insoluble” fission products that reside in the middle of the periodic chart. Although the understanding of tellurium is the most advanced finding for these fission products, it is not yet complete, especially for the new proposed salt compositions. An experiment design that accomplishes these goals with dynamic online measurement capability, as distinct from static sample analysis, will greatly accelerate the understanding of fission product behavior.

Validating the ex situ surrogate testing requires high radiation fields, high-temperature operation, and realistic production and decay of fission products. In preparation for operation of the MSRE in the 1960s, a series of experiments were conducted at the Materials Test Reactor in Idaho and the Low Intensity Test Reactor and the Oak Ridge Research Reactor at ORNL (Figure 20). A similar set of experiments is needed for next-generation molten salts for the MSR to address the concerns discussed above.

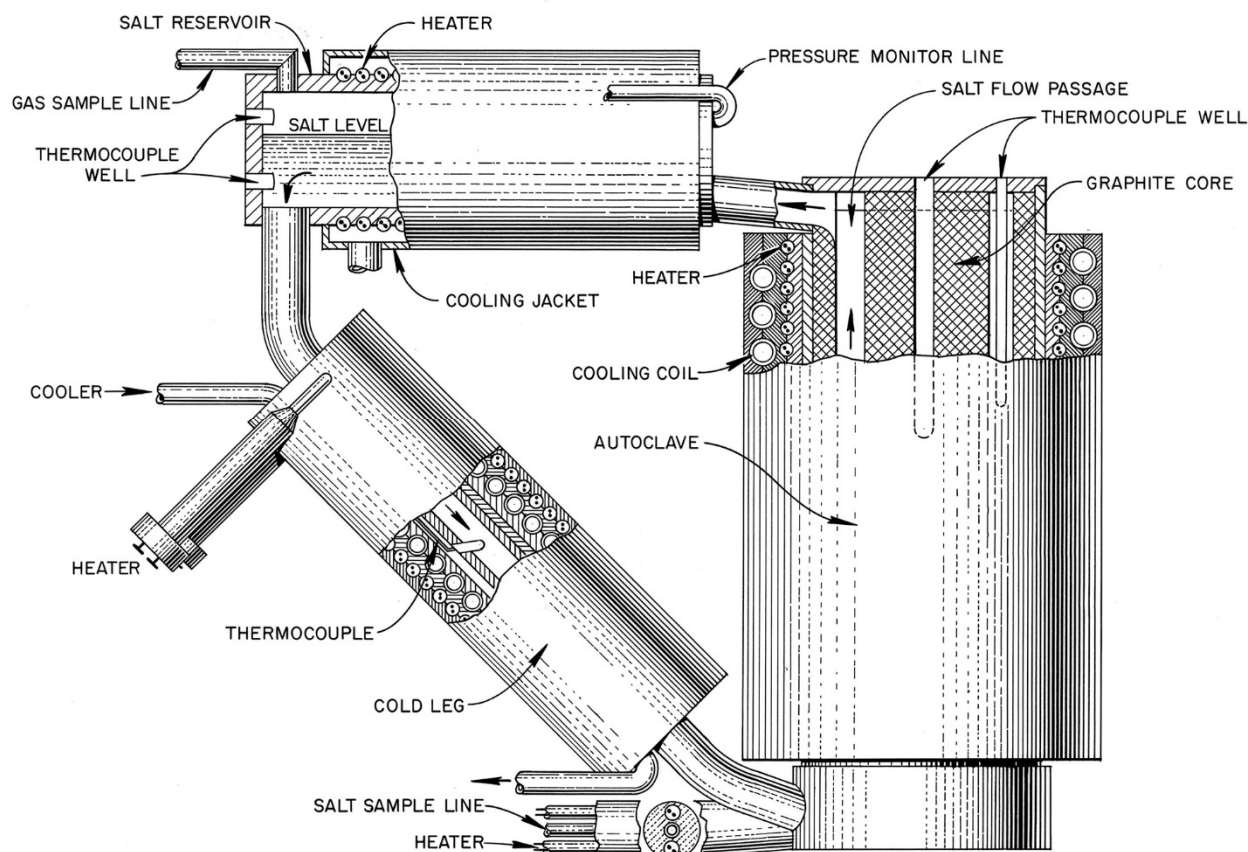

Figure 20. Natural circulation loop used in the Oak Ridge Research Reactor. The experiment tested both ${}^7\text{LiF}\text{-BeF}_2\text{-ZrF}_4$ and ${}^7\text{LiF}\text{-BeF}_2\text{-ZrF}_4\text{-UF}_4$ salts. | Image courtesy of Oak Ridge National Laboratory

4.2.2 Correlating Fission and Activation Product Behavior with Surrogates

Before establishing the ability to install a molten salt test loop within a reactor with useful emulation of a range of MSR environments, the path for learning could proceed in a limited way with out-of-pile studies using both nonradioactive and radioactive surrogates to understand the behavior of fission and activation products. Whereas in situ studies will be very complex and will require the development of advanced analytical techniques, ex situ studies can be started immediately. These studies can be carried out with both nonradiological surrogates and the actual fission products. Ex situ studies can involve capsule testing of materials prior to thermal convection loop experiments to understand the influence of the fission products on reactor materials. The anticipated radiological fission products include elements such as I, Xe, Cs, Cd, In, Sn, Sb, Te, Zr, Nb, Mo, Tc, Ra, and Tl (see Figure 19). The stable isotopic forms for most of these elements are routinely used as surrogates in adsorbent and separations studies. Therefore, laboratory studies can be performed in a variety of research settings to gain insights into fission product behavior without requiring access to hazardous radioactive materials.

There are numerous published examples of successful studies with surrogate/stable isotopes. For example, Nenoff et. al, have used stable iodine gas (I_2 and organic iodides such as CH_3I) to study the fundamental materials chemistry of iodine fission gas capture and storage materials. Structure property relationships between nanoporous materials such as zeolites and metal-organic frameworks (MOFs) and the iodine species have been detailed (Figure 21). [3] Subsequent studies indicate there is no degradation of the

framework structures due to gamma irradiation. Furthermore, stable isotope studies of cesium and strontium ion capture from aqueous and seawater solutions were performed to confirm the stability and selectivity of a crystalline silicotitanate framework before commercialization and use at the Fukushima Daiichi nuclear reactor accident site. [4]

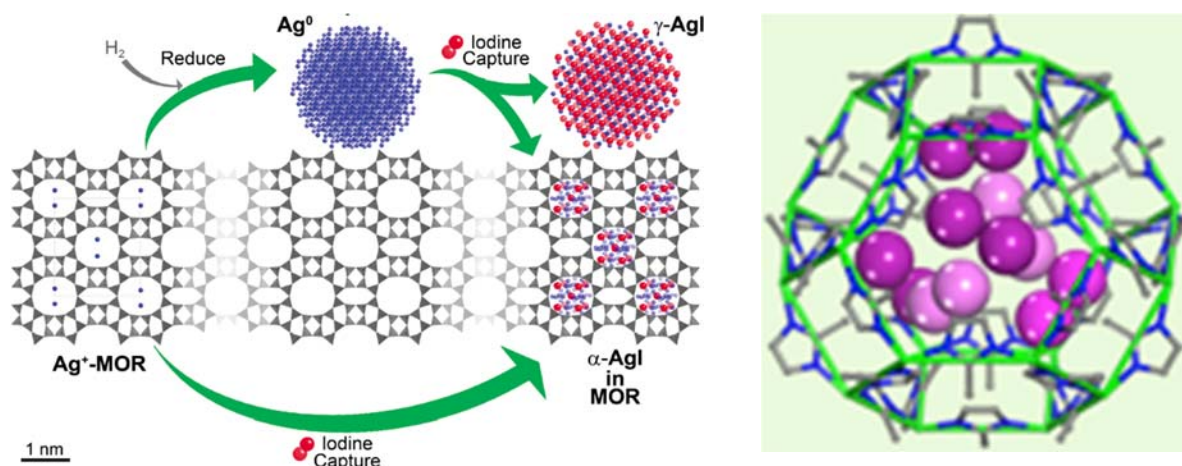

Figure 21. Metal-organic frameworks for capture of fission products (left): A schematic of iodine capture by silver-containing mordenite (MOR). Whereas pre-reducing the silver MOR yields a mixture of γ/β -AgI nanoparticles and subnanometer α -AgI, direct iodine uptake by silver-exchanged MOR produces exclusively subnanometer α -AgI. | Reprinted with permission from K. W. Chapman, P. J. Chupas, and T. M.; Nenoff. "Radioactive iodine capture in silver-containing mordenites through nanoscale silver iodide formation." *J. Amer. Chem. Soc.* 132 (26), 8897–8899, 2010. Copyright 2010, American Chemical Society. Right: Captured I_2 crystallographically located inside the small pored ZIF-8 MOF | Reprinted with permission from D. F. Sava, M. A. Rodriguez, K. W. Chapman, P. J. Chupas, J. A. Greathouse, P. S. Crozier, and T. M. Nenoff. "Capture of volatile iodine, a gaseous fission product, by zeolitic imidazolate framework-8." *J. Amer. Chem. Soc.* 133(32), 12398–12401, 2011. Copyright 2011, American Chemical Society.

Some fission and activation products are commonly substituted with surrogate elements for laboratory studies, for example, cesium for plutonium and europium for americium. Requirements include comparable atomic size, redox states, and chemical reactivity. For MSRs, the substitution of rhenium for technetium is particularly important for investigation of its solution chemistry and volatilization behaviors. [5] It is important to note that in one set of glass waste form degradation studies, rhenium transport was reported to behave quite differently from technetium transport under hydrothermal conditions. [6] Experiments reacting Re, ReO_2 , and TcO_2 with Cl_2 and HCl in molten chloride eutectics also revealed different chemical products, with a volatile TcO_xCl_y proposed. [7] Therefore, control experiments need to be performed to ensure surrogate elements possess representative chemical and physical properties compared with the fission product generated under MSR operational conditions. *Radiological studies, either with appropriate radiological isotopes or with the introduction of the appropriate decay energy, are needed to confirm the experimental results obtained with the stable or surrogate isotopes.* For example, the electron beam from a TEM can be used to irradiate surrogate fission products [8] and the resulting reactions and redox responses can be studied. [9]

As noted earlier, *modeling the effects of radiological degradation of the salt or containment metals will provide a predictive understanding of the behavior of radiological fission products in the molten salt operational environment.* It will also provide a computational means of near-term investigation of surrogate behavior compared with behavior of the actual radionuclide. These computational findings will rapidly provide information, which will necessarily be validated or revised upon completion of the more involved and complicated studies of radioactive materials following in the course of MSR development. [10]

4.2.3 Understanding the Physical and Chemical Impact of Short-lived Isotopes

Short-lived fission products in the salt are of great concern because of the chemical differences between the original elements and the daughter products. The effects from short-lived fission products are complex and special experimental methods are required to probe them as they undergo many iterations and speciations until becoming stable isotopes. For instance, ^{137}I ($t_{1/2} = 24$ sec) will be soluble in the salt; however, upon decay it becomes the entrained gas ^{137}Xe ($t_{1/2} = 3.81$ min), which can further decay to ^{137}Cs ($t_{1/2} = 30$ year) (Figure 22). If the system is flowing rapidly, the xenon will be removed from the salt (if not entrained) and will decay to cesium. Cesium from entrained ^{137}Xe will redissolve into the halide salt and will stay soluble based on its free energy as a fluoride or chloride. Alternatively, cesium from the liberated ^{137}Xe , removed during circulation, will result in cesium plating within the outgassing system. Another example is the ^{99}Zr fission product ($t_{1/2} = 2$ sec), which will decay to ^{99}Nb ($t_{1/2} = 15$ sec), then to ^{99}Mo ($t_{1/2} = 2.75$ days) and eventually to ^{99}Tc ($t_{1/2} = 2.1 \times 10^5$ year), which will stay in the metal state and not be soluble in the molten salt; thus it will plate out on the reactor components or heat exchanger. Cadmium-131,-132 ($t_{1/2} = 68$ msec, 97 msec) provides a third example; it decays to ^{131}In ($t_{1/2} = 280$ msec), ^{131}Sn ($t_{1/2} = 56$ sec), ^{131}Sb ($t_{1/2} = 23$ min), and ^{131}Te ($t_{1/2} = 25$ min), and finally to ^{131}I ($t_{1/2} = 8$ days). Iodine-131 decays to ^{131}Xe gas, which is stable and must be removed from the melt to minimize neutron poisoning in the reactor. These phenomena are depicted in Figure 22. Although individual elements can be experimentally studied with surrogates, it is difficult to study the dynamics and changing chemistries of short-lived fission products. Thus, computational methods need to be developed in tandem with the best experimental methods to provide insights into the impacts of short-lived isotopes on the reactor chemistry and corrosion.

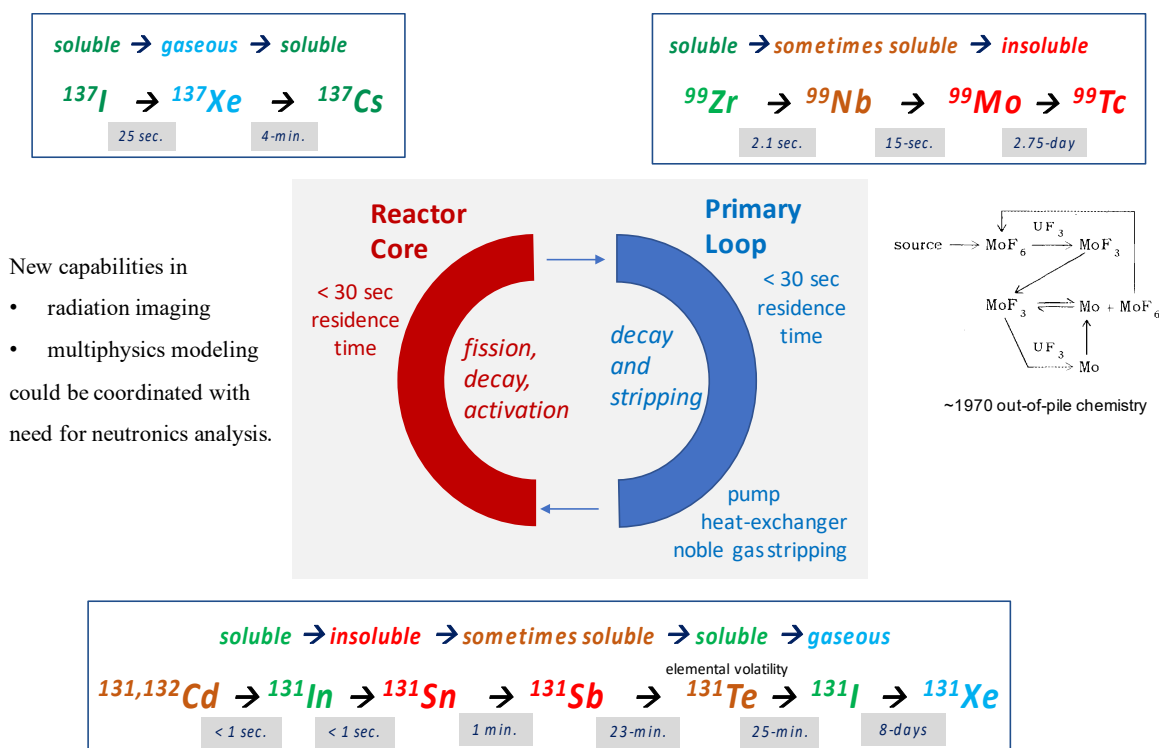

Figure 22. Examples of short-lived fission products that change solubility behavior during decay. / Image courtesy of Oak Ridge National Laboratory

References

1. S. Hazebroucq, G. S. Picard, and C. Adamo. "A theoretical investigation of gadolinium (III) solvation in molten salts." *J. Chem. Phys.* **122**, 224512, 2005; S. Hazebroucq, G. S. Picard, C. Adamo, T. Heine, S. Gemming, and G. Seifert. "Density-functional-based molecular-dynamics simulations of molten salts." *J. Chem. Phys.* **123**, 134510, 2005.
2. E. L. Compere, S. S. Kirslis, E. G. Bohlmann, F. F. Blankenship, and W. R. Grimes. *Fission Product Behavior in the Molten Salt Reactor Experiment*, ORNL-4865, Oak Ridge National Laboratory, 1975.
3. T. M. Nenoff, M. A. Rodriguez, N. R. Soelberg, and K. W. Chapman. "Silver-mordenite for radiologic gas capture from complex streams: Dual catalytic CH₃I decomposition and I confinement." *Micro. Meso. Mater.* **200**, 297–303, 2014; K. W. Chapman, P. J. Chupas, and T. M. Nenoff. "Radioactive iodine capture in silver-containing mordenites through nanoscale silver iodide formation." *J. Am. Chem. Soc.* **132**(26), 8897–8899, 2010; D. F. Sava, K. W. Chapman, M. A. Rodriguez, J. A. Greathouse, P. S. Crozier, H. Zhao, P. J. Chupas, and T. M. Nenoff. "Competitive I₂ sorption by Cu-BTC from humid gas streams." *Chem. Mater.* **25**(13), 2591–2596, 2013; D.F.S. Gallis, I. Ermanoski, J. A. Greathouse, K. W. Chapman, and T. M. Nenoff. "Iodine gas adsorption in nanoporous materials: A combined experiment–modeling study." *Ind. Eng. Chem. Res.* **56**(8), 2331–2338, 2017; J. T. Hughes, D. F. Sava, T. M. Nenoff, and A. Navrotsky. "Thermochemical evidence for strong iodine chemisorption by ZIF-8." *J. Am. Chem. Soc.* **135**(44), 16256–16259, 2013.
4. T. M. Nenoff and J. L. Krumhansl. "Cs⁺ removal from seawater by commercially available molecular sieves." *Solvent Extraction and Ion Exchange* **30**, 33–40, 2012; C. A. Abney, K. M. L. Taylor-Pashow, S. R. Russell, Y. Chen, R. Samantaray, J. V. Lockard, and W. Lin. "Topotactic transformations of metal-organic frameworks to highly porous and stable inorganic sorbents for efficient radionuclide sequestration." *Chem. Mater.* **26**, 5231–5243, 2014.
5. M. H. Langowski, J. G. Darab, and P. A. Smith. *Volatility Literature of Chlorine, Iodine, Cesium, Strontium, Technetium, and Rhenium: Technetium and Rhenium Volatility Testing*, PNNL-11052, Pacific Northwest National Laboratory, 1996.
6. D. A. McKewon, A. C. Buechele, W. W. Likens, D. K. Shuh, and I. L. Pegg. "Tc and Re behavior in borosilicate waste glass vapor hydration tests." *Environ. Sci Technol.* **41**(2), 431–436, 2007.
7. V. A. Vokovich, I. May, J. M. Charnock, and B. Lewin. "Reactions and speciation of technetium and rhenium in chloride melts: A spectroscopy study." *Phys. Chem. Chem. Phys.* **4**, 5753–5760, 2002.
8. M. Nyman, B. X. Gu, L. M. Wang, R. C. Ewing, and T. M. Nenoff. "Synthesis and characterization of a new microporous cesium silicotitanate (SNL-B) molecular sieve." *Micro. Meso. Mater.* **40**, 115–125, 2000.
9. C. L. Tracy, M. Lang, J. M. Pray, F. Zhang, D. Popov, C. Park, C. Trautmann, M. Bender, D. Severin, V. A. Skuratov, and R. C. Ewing. "Redox response of actinides materials to highly ionizing radiation." *Nature Comm.* **6**, 6133, 2015.
10. A. Dunn, R. Dingreville, and L. Capolungo. "Multi-scale simulating radiation damage accumulation and subsequent hardening in neutron-irradiated α -Fe." *Model. Simul. Mater. Sci. Eng.* **24**(1), 015005, 2015; R. Dingreville and S. Berbenni. "On the interaction of solutes with grain boundaries." *Acta Mater.* **104**, 237–249, 2016.

5. FRD 4: Understanding Materials Compatibility and Interfacial Phenomena

5.1 Background and Current Status

The reemergence of MSR concepts for future energy production has prompted an evaluation of the state of knowledge and fit-for-use (or lack of such) of materials in contact with the coolant/fuel. Materials compatibility under such extreme conditions presents unique challenges, many of which have been defined and addressed, at least for fluoride salts, during the course of the MSRE and subsequent MSBR program. [1] However, concerns remain regarding the chemical compatibility and application of Ni-Mo alloys (specifically Hastelloy N) in molten fluoride salt because of the lack of long-term operational experience and the possibility of embrittlement by fission products. As an expanded performance envelope has been proposed in some recent MSR designs, including higher temperatures and use of chloride salts, it is apparent that alternative structural materials need to be evaluated. Chloride salts for MSR applications have a much smaller compatibility database, require higher temperatures to liquefy, and appear to display greater corrosion issues, although results show a great degree of variability. Candidate nickel-based alloys and/or advanced ceramics, such as SiC-SiC composites, encompass greater alloy strength (without significant degradation of fracture toughness), radiation tolerance, and resistance to corrosion and oxidation than the alloys developed during the MSRE.

Molten salt coolants and fuels present a number of extreme environmental demands on reactor structural and functional materials. These include

- Resistance to corrosion and embrittlement by the fuel/coolant salt
- Low rates of mass transfer burden due to thermal or dissimilar material gradients in the reactor system
- High strength and fracture toughness with minimal/acceptable degradation over time due to radiation damage and high temperatures
- Corrosion/oxidation resistance by the external reactor environment (whether air or a secondary coolant)
- Fabricability, including joining and cladding (for certain applications)

In general, materials degradation processes underlying these requirements are approached as either irradiation or chemical compatibility effects. Significantly less attention is paid to their combined influence or the origins of those effects at the atomistic scale. Similarly, although mechanical and chemical behaviors tend to be treated separately, their effects can be synergistically compounding; relevant examples include stress corrosion cracking in aqueous systems and oxidative embrittlement of nickel-based alloys. To some extent, the problems can be separated by using corrosion-resistant coatings on materials to provide adequate mechanical strength, although this practice introduces the additional issue of coating integrity. The manifestations of these effects can be different for alloys, graphite, and silicon carbide composites.

Materials degradation (corrosion) occurs at an interface between the salt and a metal in a MSR. Thus, understanding the molecular-level chemistry of the fluid, solid, and gas interfaces is key to controlling the interfacial reactions that result in materials degradation. Interfacial behavior pertinent to MSRs is an under-investigated area—in particular at atomistic scales—because the boundary regions between phases or molecular regions comprise only a small fraction of all species in any sample, making their focused investigation particularly difficult. For MSRs, *a molecular-level understanding is needed of the salt/alloy,*

salt/graphite, salt/gas, and salt/salt interfaces; and an understanding of their molecular structure and chemical reactivity will provide important insights into mitigating phenomena such as corrosion, fission product off-gassing, gas entrainment, and material precipitation.

5.2 Technical Challenges and Research Directions

5.2.1 Advancing Spectroscopic and Scattering Investigation of MSR Interfaces

The ability to characterize the molecular-level chemistry that takes place at the liquid/solid interface is key to understanding interfacial reactions such as corrosion. A number of surface-sensitive techniques have been developed in the 20th century to address the challenges of characterizing an interface, including infrared (IR) adsorption spectroscopy (attenuated total reflectance, reflection-adsorption infrared spectroscopy, transmission IR), Raman spectroscopy, sum frequency generation, UV-vis spectroscopy, and x-ray and neutron-based techniques, such as reflectometry. [2] Second harmonic generation, which was used to investigate molecular monolayers adsorbed to surfaces, [3] has been extended to study the air-water interface [4] and more recently the interfaces of spherical particles [5] and colloidal systems. [6–8] Recent developments in quantum-beam approaches have also enabled the investigation of interfacial structure and reactivity. Perhaps of greatest note are x-ray and neutron reflectivity, which provide a molecular density profile of molecular ordering as a function of distance from the interface. [9] For example, a review of the water/mineral interface reveals perturbations of the liquid structure near the solid surface boundary. [10] This liquid structure is expected to have a crucial influence on physical interfacial behaviors—such as diffusion, adsorption, and dielectric properties—that directly affect phenomena of immediate pertinence, such as metal precipitation or alloy corrosion.

Numerous grazing incidence techniques have also been developed for the investigation of various interfaces. For example, grazing incidence XAFS (GI-XAFS) has been used to investigate the speciation of Er^{3+} at the electrolyte-vapor interface; it revealed simple hydration of Er^{3+} in the bulk phase to form $[\text{Er}(\text{OH}_2)_8]^{3+}$, but formation of a neutral $[(\text{H}_2\text{O})_{6-7}\text{ErCl}_3]$ at the surface (Figure 23). [11] This work was complementary to an investigation of the same system using x-ray reflectivity. [12] Grazing incidence x-ray diffraction provides information regarding in-plane structure and ordering at interfaces, and x-ray fluorescence near total reflection provides element-specific information regarding the binding and coverage of target metal ions.

There is a need to characterize the molecular-level chemistry at the molten salt/solid interface. The use of approaches like those described to investigate interfaces within a molten salt would enable the identification of metal species and oxidation states in the salt phase. There is also great potential to answer unresolved questions regarding corrosion mechanisms in MSRs, in particular via the development of hyphenated techniques in which manipulation of interfacial behavior is achieved electrochemically. Corrosion studies are commonly performed by applying a voltage to a metal surface or creating a chemically reactive environment and observing how metal components react. [13–15] Electrochemical impedance spectroscopy is routinely used to explore corrosion of a metal surface, because it provides information regarding solution phase resistance, charge transfer properties of the surface, and diffusion characteristics of the solution phase. Traditional corrosion analysis is performed using post-mortem methods—such as transmission electron microscopy with electron energy loss spectroscopy or energy dispersive spectroscopy, x-ray diffraction, and optical spectroscopy—in which a sample is analyzed after retrieval from a reaction vessel. While informative, this approach is limited by challenges associated with discerning the chemistry after it has occurred. In contrast, the spectroscopic approaches discussed above allow the direct interrogation of the interface itself and, in some instances, are even amenable to in situ reaction monitoring.

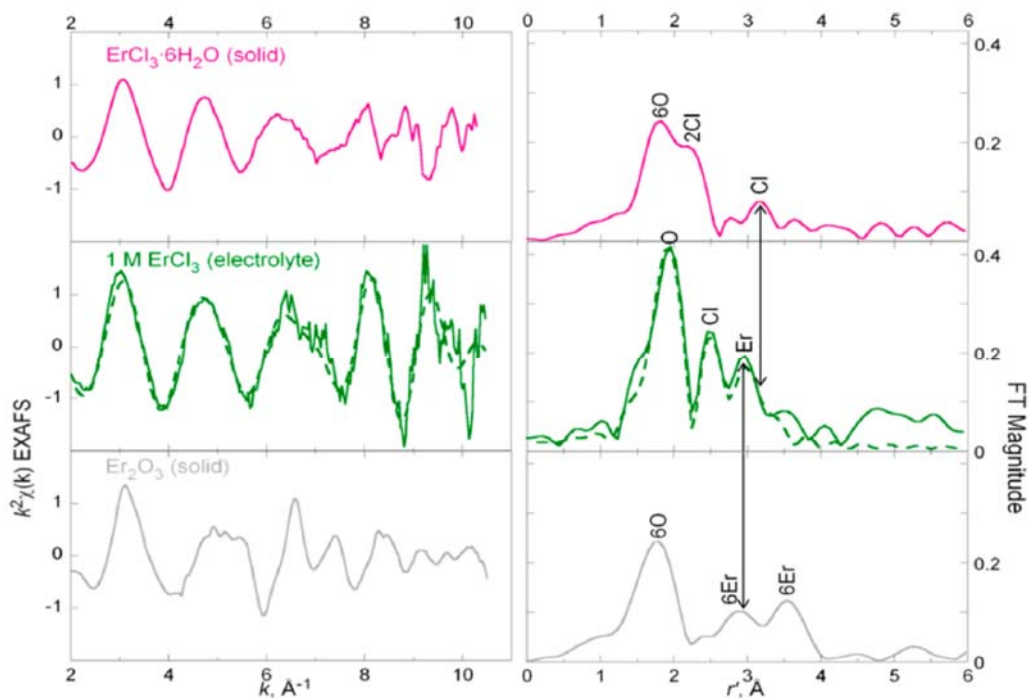

Figure 23. GI-XAFS results reveal unanticipated molecular complex formation at the water/gas interface. The extension of similar techniques to molten salts could be used to answer fundamental questions regarding corrosion mechanisms, particularly if successfully paired with electrochemical control. | Reprinted with permission from M. K. Bera, G. Luo, M. L. Schlossman, S. Lee, and M. R. Antonio. "Erbium(III) coordination at the surface of an aqueous electrolyte." *J. Phys. Chem. B* 119(28), 8734–8745, 2015. Copyright 2015, American Chemical Society.

Development of multi-faceted in situ and in operando approaches to observe interfacial physical phenomena is needed to advance MSR development. The advancement of corrosion science is greatly enhanced by the ability to collect information as the chemistry occurs. For example, a combination of electrochemical methods with advanced x-ray and neutron scattering techniques would allow the exploration of corrosion in operando, providing process-relevant information that cannot be observed during traditional post-mortem analysis.

5.2.2 Understanding Materials Compatibility in the Molten Salts Reactor Environment

Results from the Aircraft Nuclear Propulsion program in the 1950s and the MSRE in the 1960s clearly showed the benefits of the Ni-Mo alloy system for use with molten fluoride salts. Most existing high-temperature nickel-based superalloys were designed for operation in oxidizing external atmospheres (e.g., air in the MSRE radiator and secondary coolant piping/tanks, and supercritical steam in the MSBR secondary heat exchanger). Therefore, their corrosion resistance is derived from the formation of a passivating layer of chromia or alumina scale. The situation with regard to salt-side corrosion is fundamentally different because of the dissolution of passivating oxide layers in fluoride and chloride salts. Corrosion in these salts is instead controlled by the thermodynamic stability of the bare alloy surface in the halide salt environment. Degradation occurs by dissolution of the containment material into the salt, driven by the difference in free energy of formation between the salt constituents and the most susceptible transition metal corrosion product (the more negative the free energy of reaction, the greater extent to which the reaction will occur). In the simplest systems, these reactions are governed by elemental solubility considerations and the kinetics of the rate-controlling step of the dissolution process. Those dependencies are reflected in the fundamental rate equation for solvation of solids in liquids [16]:

$$J_i = k_{s,i}(C_{o,i} - C), \quad (5.1)$$

where J_i is the rate of mass loss of element i due to dissolution, $C_{o,i}$ is the solubility of component i in the salt, C is the actual concentration of i in the bulk of the liquid, and $k_{s,i}$ is the effective solution rate constant. (Each constituent of the condensed phase is separately governed by Eq. (5.1) but, for simplification, the subscripts are not used hereinafter.) Because J is proportional to $(C_o - C)$, high solubilities do not necessarily translate into high dissolution rates (and vice-versa), because the driving force for dissolution depends on the actual concentration of the solute in the salt as well as C_o . [17, 18] Elimination of concentration gradients by convective or mechanical mixing thus forms the basis for the difference between isothermal and/or stagnant salt systems and nonisothermal dynamic ones (such as in most reactor schemes) with regard to material stability. This can be particularly important for heat exchangers and systems with large temperature differentials in which deposition can block flow passages and lead to thermal excursions or excessive localized radioactivity. Furthermore, preferential dissolution of one constituent into the salt can destabilize the structure of the solid or its interface with the liquid, in some cases, leading to porous zones.

Under nonisothermal conditions normally encountered in reactor systems, [19] C should be uniform within a flowing liquid system. Consequently, J is only dependent on time (t) through k_s , because $(C_o - C)$ is effectively constant. Common practice then allows J to be described in a generalized kinetic form:

$$J = m/t^n. \quad (5.2)$$

The time dependence of the dissolution rate process (n) can be determined by fitting measured mass loss (m) using Eqs. (5.1) and (5.2). Therefore, direct measurement of mass loss from corrosion affords a straightforward method of determining a key kinetic parameter for dissolution, yielding information regarding rate-controlling steps (surface reaction, liquid-phase diffusion through boundary layer, and solid-state diffusion) [16, 17, 20, 21] for corrosion mechanisms under nonisothermal conditions. Collection of these data at various temperatures affords the representation of different positions in a molten salt loop. Such kinetic information can guide and validate appropriate modeling and lifetime prediction approaches for a particular solid-salt system.

The flux description described by Eq. (5.1) applies equally well to deposition when $C > C_o$. If the dissolution and deposition behaviors are controlled by the respective forms of Eq. (5.1), measurements of mass change as a function of loop position (x) should yield data resembling the schematic depiction shown in Figure 24. Using the appropriate analysis methods and simplifying assumptions, measurements of the mass—or, for alloys and compounds, composition change—as a function of loop position (and therefore temperature) can provide further data regarding kinetics and the rate controlling mechanism of mass transport associated with a given material-liquid salt system. Initial results could be obtained in ex situ studies to guide future experimental investigations.

The free energy driving force for dissolution of the solid can be controlled by manipulating the redox potential of the salt. While more reducing conditions were found to suppress corrosion, other reactions between the salt and solid, such as alloying, become more likely. [22] Therefore, corrosion control by manipulation of the redox potential is bound by the necessity of identifying conditions that minimize both oxidative and reductive degradation reactions; limiting other deleterious reactions; and, for fuel salts, maintaining the necessary U^{3+}/U^{4+} ratio. The ability to effectively control the salt redox properties in real time requires implementation of online monitoring (discussed in Section 3).

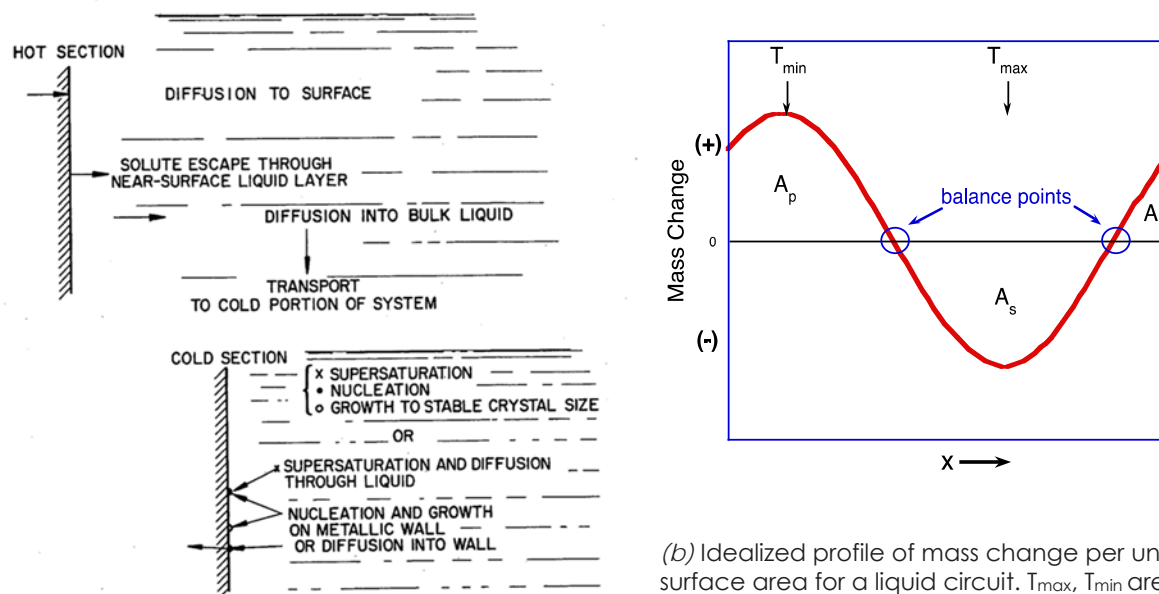

(a) Mass transfer schematic

(b) Idealized profile of mass change per unit surface area for a liquid circuit. T_{max} , T_{min} are maximum, minimum loop temperatures, respectively; x is loop position.

Figure 24. Steps and balance points in temperature-gradient mass transfer. / Image courtesy of Oak Ridge National Laboratory

Impurities in the as-produced salts, such as HF, HCl, H₂O; residual metal oxides; and/or polyvalent metal ions can also cause or affect degradation. They can change the driving forces (free energies) for compound formation/alloying of the solid, provide new reaction pathways for dissolution and deposition, and affect kinetic factors governing mass transfer of the principal products. In closed systems with purified salts, these impurity effects should be limited and insignificant (after an initial short time period) compared with the persistent, continuous corrosion mechanisms.

As discussed in Section 4, fission products that develop in the salt during reactor operation can also impact materials performance. Tellurium, for example, significantly impacts the mechanical performance of Hastelloy N in fluoride salts by promoting cracking via leaching of chromium from the alloy. However, the cracking can be reduced by controlling the redox potential of the salt through variation of the U³⁺/U⁴⁺ ratio, as shown in Figure 25. [23] This approach will also affect the dissolution rate of the alloy constituents. A proven alternative approach was using metal additions to form metal alloys, for example, adding niobium reduced the propensity for this type of embrittlement. [23]

A rigorous predicative capability for corrosion and environmental effects in the molten salt operating environment is currently lacking. Although this gap is not unique with respect to MSR systems, the technology would certainly profit from research to advance the fundamental understanding of corrosion processes at the atomistic level, as well as provide the necessary underpinnings and experimental data for accurate modeling and simulation of materials behavior. Such developments would facilitate the identification and remediation of design issues while quantifying lifetime prediction for MSR concepts. A focus on predictive capabilities would provide the framework to conduct a coordinated experimental program in corrosion, mass transfer, physical and mechanical properties, and radiation effects. These would directly impact and inform the modeling effort and provide the means for validation of models and the simulations built on them. Such efforts need to address

- Reaction pathways and kinetics
- Prediction of failure mode and lifetime

- Materials, component, and structural design rules
- Mechanistic underpinnings for input into modeling and simulation modules
- Coupling of radiation and mechanical effects to corrosion and mass transfer phenomena

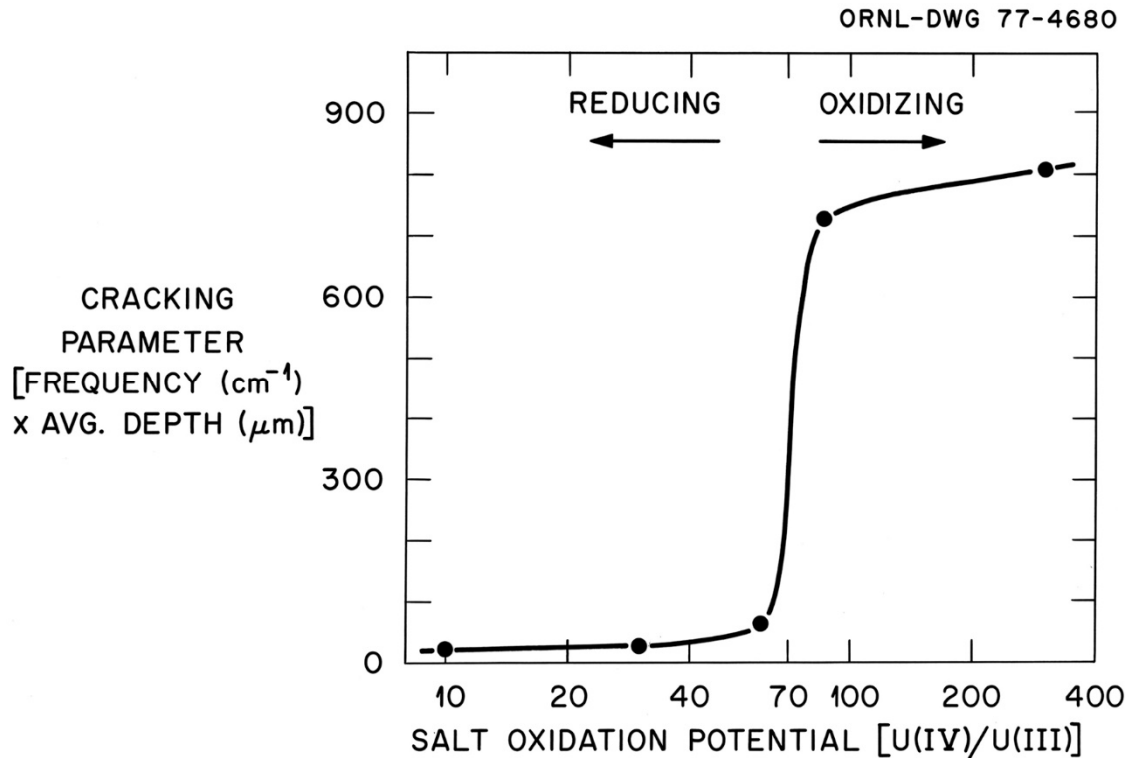

Figure 25. Plot showing the effect of the salt oxidation potential (as measured by U^{4+}/U^{3+}) on the propensity for tellurium embrittlement of Hastelloy N. | Image courtesy of Oak Ridge National Laboratory

5.2.3 Understanding Degradation Processes at the Material–Salt Interface

To understand the degradation of salt-facing structural materials, it is critical that the corrosion mechanisms at the material–salt interface be well understood. However, to date, studies have mostly relied on macroscopic ex situ measurements in static conditions, leaving a knowledge gap in our understanding of the nature of the material–salt interface and the kinetic parameters that determine its evolution with time. This knowledge gap needs to be addressed by designing, constructing and establishing techniques and methodologies for in situ characterization of the material–salt interface (see Section 5.2.1). In situ spectroscopy/diffraction analysis of material surfaces in the molten salt under both static and ex situ flow loop testing will greatly advance the understanding of relevant corrosion mechanisms.

To aid in the understanding of interface behavior under realistic conditions, flow loops should be constructed for the integration of thermal gradients, fretting, and erosion into the mechanism studies (see Figure 20). In-core management and monitoring of corrosion is an area of research requiring much more investment, and flow loop testing is the ideal first step in investigating potential in situ monitoring methods and testing new materials. Flow loops will also allow for the effects of joining different structural materials together to enable a clearer understanding of the overall integrity of the system. Use of in situ experimental techniques to study the evolution of the material–molten salt interfacial chemistry is critical to understanding and predicting the degradation behavior and lifetime of the material of interest.

Characterizing any surface deposits that are formed in the reactor as a result of exposure to molten salts and fission products, and identifying and quantifying the elements that are preferentially leached out of the material, will lead to an understanding of the chemical interactions and reaction kinetics between the molten salt and the material. Further, in situ material surface analysis can be combined with in situ salt studies using techniques such as microfluidic sampling and inductively coupled plasma optical emission spectroscopy.

To accurately model material degradation in molten salt, accurate inputs are required; and without a solid base of experimental data, a modeling effort would be limited in usefulness. For this purpose, a coordinated effort is needed to gain fundamental experimental data on simple model systems, in which parameters can be accurately controlled and questions or hypotheses can be answered, coupled to more complex experiments in a test loop. *Greater emphasis must be placed on the use of controlled, science-based experiments to find thermodynamic parameters, diffusion rates, and kinetic dissolution parameters that control corrosion and degradation of materials at the molten salt interface.* Targeted experiments may include capsule testing, flow loops, calorimetry, or in situ techniques designed to measure the dissolution of species in salt.

Using data specifically acquired to generate thermodynamic databases, thermodynamic models can be constructed. While thermodynamic modeling is not necessarily predictive, it is an important step toward more complex predictive models that account for corrosion, materials aging, and defect kinetics. CALPHAD (Computer Coupling of Phase Diagrams and Thermochemistry) [24] codes have proven to be a useful tool for making thermodynamic predictions and have already been used for calculating phase equilibria in salts. However, the calculation of phase equilibria relevant to alloy–salt interactions requires fundamental thermodynamic parameters, such as Gibbs free energies and solubilities, which can only be obtained from experimental data (see Section 2).

Beyond thermodynamic modeling, true predictive capability will require the development of multiphysics models that incorporate corrosion kinetics with radiation and salt chemistry. The purpose of these models is to use the mechanistic understanding of materials behavior to forecast the behavior of new conceptual materials in these extreme environments. This will allow for the development of materials with targeted properties.

Computational methods need to be developed and coupled to experimental data to predict corrosion due to thermal gradients, fission products, and dynamic chemistries in the MSR. Models need to be tightly coupled to fluid flow, heat transport, and mass transport; and the production and dispersion of soluble gases, such as xenon or tritium (from neutron-induced fission of ${}^6\text{Li}$), need to be understood. The exposure of the salt to an inert atmosphere in the pump section can be modeled as a boundary condition allowing the entrainment of gases (helium and/or argon) into the coolant. Understanding the distribution of tritium, when present, is important for determining the optimal placement of tritium-getters and determining places in the coolant loop where tritium might naturally deposit or evolve. To capture these effects, models need to be developed to determine a sink of tritium through off-gas or other chemical reactions.

Understanding the interfacial chemistry will help predict material behavior and lifetime and accelerate the deployment of MSRs. As an added benefit, the development of these in situ techniques for molten salts will also help with real-time monitoring of the quality of the salts in the reactor and time-dependent transfer and disposition of materials for accountability.

5.2.4 Understanding the Combined Effect of Chemistry and Radiation at the Interface

The generation of fission products and their subsequent decay is well documented and understood and supports accurate predictions of their production in molten salt systems. This enables the prediction of

fission product concentrations with high accuracy. However, it does not explain the evolution of dissolved fission product concentrations completely because of the dynamic effects associated with short-lived fission products and the complex solubility behavior of many transition metals. Although previous studies have never revealed any new chemical species due specifically to radiation-induced-reactions in molten coolant or fuel salt, the possibility exists for new chemistry and compounds to be produced by the highly energetic fissioning salt environment. Some of these could have detrimental effects (especially if the reactor operates for 30 years).

The most dramatic impact of ionizing irradiation occurs during the self-irradiation (due to fission and activation products) of solid salts at lower temperatures, with the production of metal centers and reactive halogens (F_2), and must be considered for the case of spent salt storage and capsule irradiation (see Appendix A, Section 2.3.3). Based on the composition of the salt, the radiolysis effects of each solid salt will be unique. In the case of mixed halides—including mixed halides involving fission products such as iodo-fluorides and iodo-chlorides—interhalogens are very reactive, with different chemical interactions from those of pure halogen salts. In particular, boron and iodine are hard to remove, and they each have long-term effects in molten salts. High-intensity gamma-radiolysis studies of solid salt will need to be conducted as a precursor activity to in-pile salt irradiations to define the necessary safety envelopes for the experiment.

The interactions at the gas–salt interface in the MSRE pump bowl appeared to be much more complex than in the salt solution or at the container–salt interface (see Figure 18); and molten salt mist was found in the gas space, leading to deposition of fission products. No corrosion acceleration—akin to that shown in Figure 26 for zirconium in water reactors—was seen during intense irradiation of coolant salt to high fluence and high power density. So far, only the tellurium embrittlement effect was obvious for fluoride fuel salt in the MSRE, as shown in Figure 27.

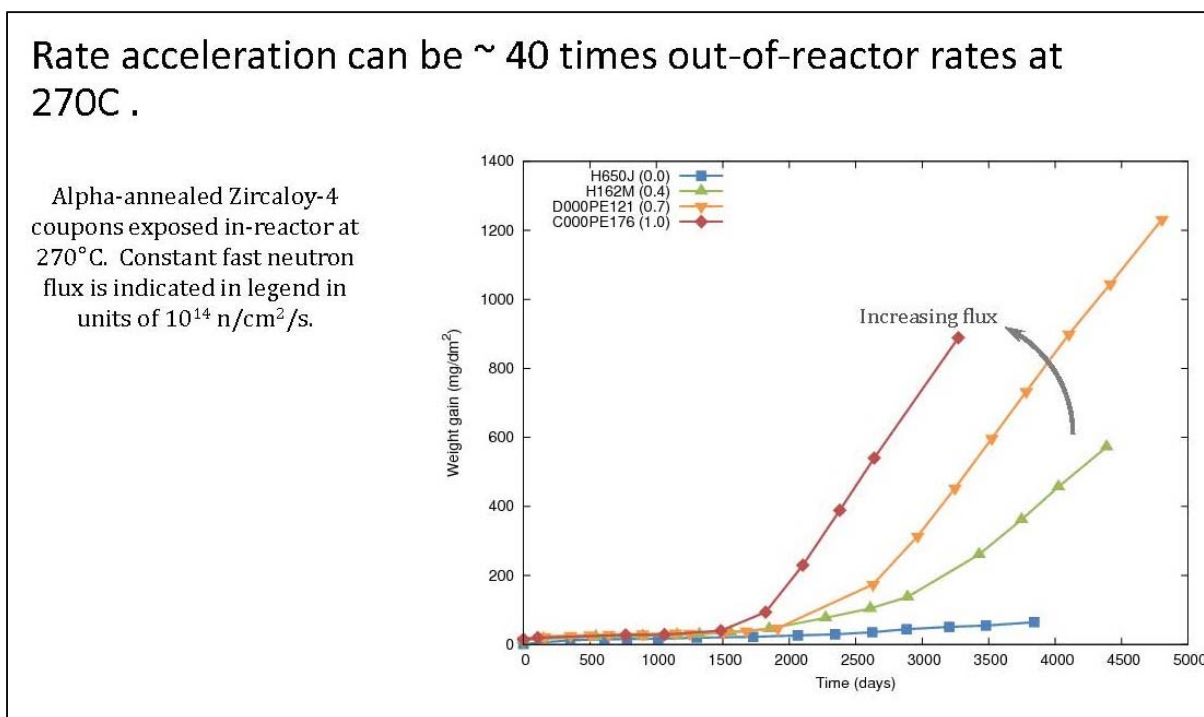

Figure 26. Irradiation enhancement of corrosion rates. | B. F. Kammenzind, J. A. Gruber, R. Bajaj, and J. D. Smee. "Neutron irradiation effects on the corrosion of Zircaloy-4 in a PWR environment." *Paper B-T-3965, 18th International Symposium on Zirconium in the Nuclear Industry, Hilton Head, South Carolina, May 15–19, 2016. Used by permission.*

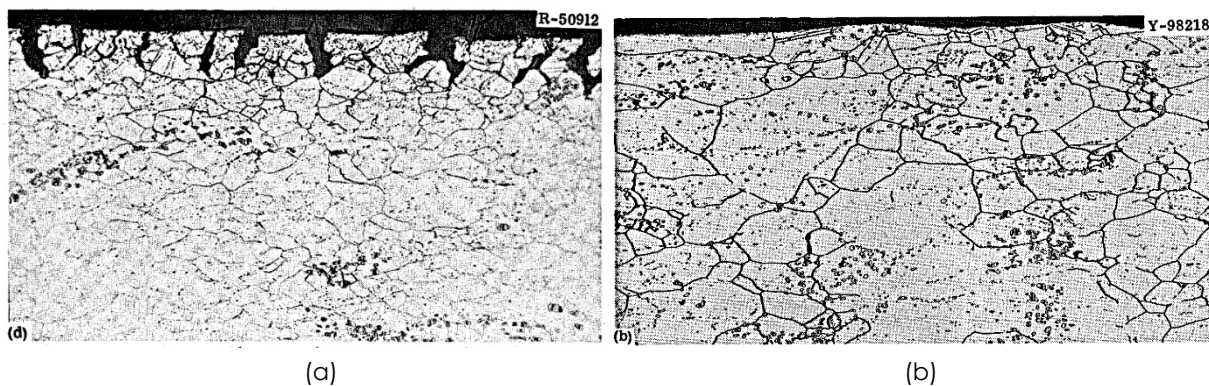

Figure 27. Cross-section analysis of INOR-8 (heat 5065) sample tested at 25 °C (a) after being exposed to the MSRE core for 19,136 h above 500 °C and irradiated to a thermal fluence of $1.5 \cdot 10^{21}$ neutrons/cm² and (b) after being exposed to static unenriched fuel salt for 19,136 h above 500 °C. | Image courtesy of Oak Ridge National Laboratory

5.2.5 Predicting Interfacial Interactions between Molten Salts and Structural Materials and/or Gases

There is a need for predictive computational models to describe the molecular, mesoscale, and macroscale interfacial processes that occur in an MSR over a wide range of time scales (from nanoseconds to years) (see Figure 28). There are two primary types of interfaces relevant to MSRs: (1) molten salt fluid–solid and (2) cover gas–molten salt. Both interface types need to be understood in terms of fundamental interactions and interfacial transport processes. Relevant phenomena include

- Noble metal (fission products) plating on both the structural materials and the moderator
- Deposition of fissile materials on the structural interface and subsequent migration into the bulk solid phase
- Nucleation of particles and transport and collection at the gas–liquid interface that adversely affect the mass transport of volatile fission products into the gas phase
- Gas-phase entrainment into the molten salt (in the form of microbubbles from the cover gas) either by design or unintentionally
- Entrainment of molten salts in the gas (mist formation)
- Corrosion of structural components

The underlying timescales span from nanoseconds, for gas diffusion, to months to years for corrosion. Current modeling approaches can treat fluids and solids on timescales that typically are from picoseconds to a microsecond at the atomistic/quantum level of theory, and microseconds to seconds at the mesoscale level of theory. *Extending the time scale assailable by predictive simulations can provide essential missing knowledge of interfacial transport phenomena, in many instances available by no other practical means, thereby aiding the design approaches for commercial MSRs.*

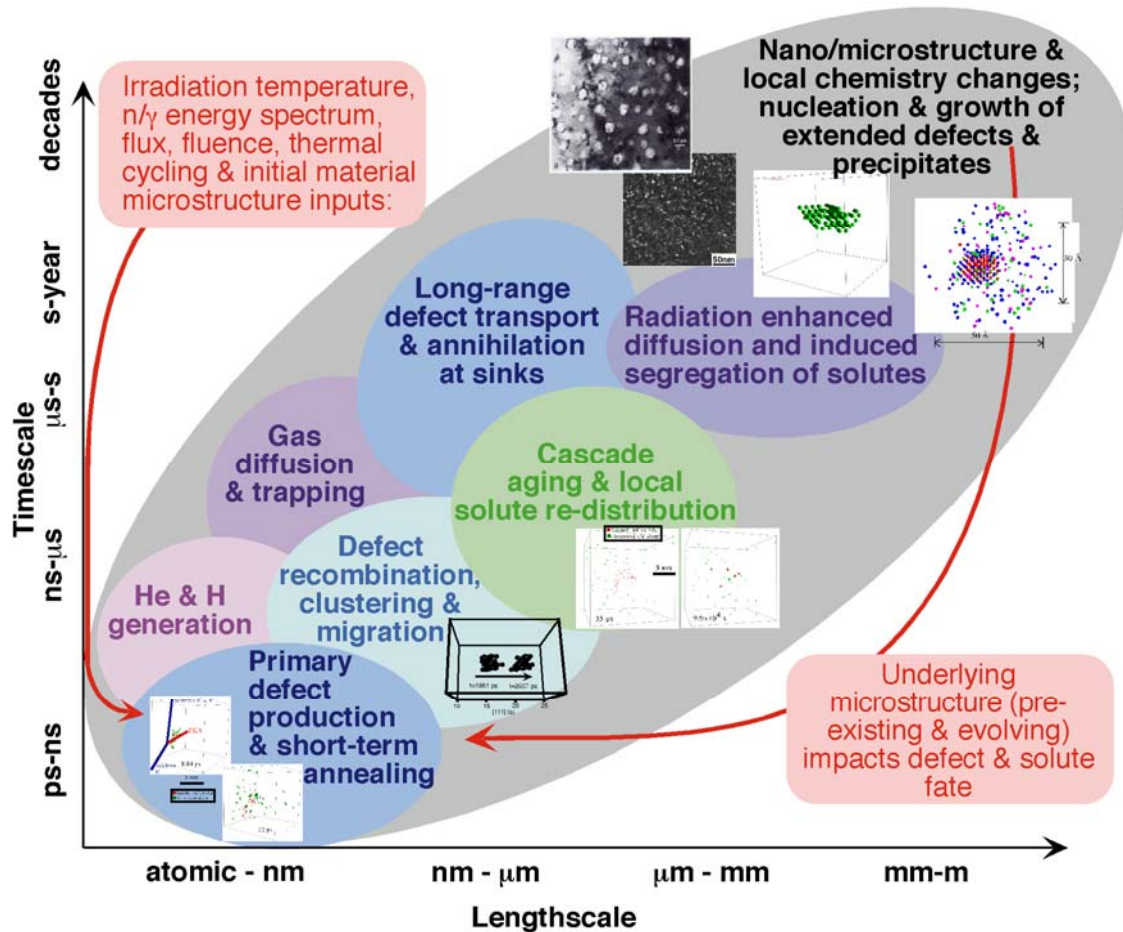

Figure 28. Illustration of the length and time scales (and inherent feedback) involved in the multiscale processes responsible for microstructural changes in irradiated materials. | Reprinted from B. D. Wirth, X. Hu, A. Kohnert, and D. Xu. "Modeling defect cluster evolution in irradiated structural materials: Focus on comparing to high-resolution experimental characterization studies." *J. Mater. Res.* 30, 1440–1455, 2015. Used by permission.

There are several critical needs that must be addressed for interfacial interactions between molten salts and structural materials and/or gases that pose significant challenges to the current computational-based approaches:

- Prediction of long time processes (particularly regarding corrosion) by scaling up insights from molecular interactions
- Prediction of interfacial transport processes
- Prediction of surface layer formation leading to degradation of reactor performance with fission processes (e.g., metal plating)
- Prediction of surface layer formation leading to degradation of heat exchangers
- The ability to couple chemical and physical phenomena with microstructure and composition

One of the challenges is that interfacial regions are inherently inhomogeneous, making transport phenomena near such regions difficult to quantify. The transport of reactive chemical species across interfaces and/or species reactivity at the interface are particularly challenging. Nevertheless, a concerted approach coupling information from simulations at the quantum level of theory (first principles MD),

classical MD with accurate/informed force fields, and mesoscale simulations will provide far more insight into the physicochemical behavior of interfaces than is currently available. Polarization effects and chemical changes dominate phenomena at interfaces; therefore, the combination of methods is a necessity despite the challenges of passing information from one level of theory to another in either direction. This multiscale simulation approach will provide new understanding of interfacial transport phenomena in view of the challenges of experimental methods for probing molten salt interfaces under realistic conditions of reactor operation. Hence the research directions should follow from the following three platforms.

1. **Predict dynamics at molten salt–materials and molten salt–gas interfaces:** First principles quantum mechanical MD (QM/MD) simulations are needed for modeling redox states of salt mixtures, fission and activation products, structural metals, and other impurities near the interfacial region to predict transfer of species to and from the salt across the interface. The results of this type of investigation provide information on the mobility of interfacial species; residence times in the interfacial region; and changes in interfacial structure—including the formation of complexes and nucleation of particles—that lead to precipitation and coating. With these data in hand, classical mechanical simplifications can be constructed to allow for longer time-scale and larger length-scale coarse-grained simulations. As with all modeling, comparison with experimental data is indispensable for validating calculated results and for imparting confidence in the computational results.
2. **Develop approaches for coupling chemical and physical phenomena with microstructure and composition:** Various simulations of molten salts have been performed to study the structure and dynamics of bulk molten salt mixtures using classical MD (CMD) simulations. Equipped with new information from interfacial QM/MD, classical models can be built considering redox states, interfacial speciation, and polarization to carry out simulations that allow for species to cross the interfacial region at representative length and time scales. Of interest are species involved in corrosion of the solid–liquid interfaces, migration of fission products into structural material defects, and escape of volatiles into the gas phase in contact with the molten salt phase. In this effort, trends of mesoscopic mass transport can begin to be assessed and proposed for the next level of coarse-graining models aimed at stimulating rate-based processes
3. **Predict diffusion and chemical transformations in confined spaces near interfaces:** Mesoscale models and transport simulations based on classical conservation laws of convective-diffusive-reactive processes in nonequilibrium, when calibrated by subscale models (typically CMD), allow for further insight into trends of species transport and reactivity in interfacial regions on time scales of up to seconds and length scales of tens of microns. For example, phase field methods coupled with accurate thermodynamic data sets and kinetic data can provide detailed transport simulations with chemical reactivity, including nucleation and new phase formation. Together with cluster dynamics methods, mesoscale approaches can also address radiation damage processes within this framework.

Experimental and reactor results can be used to improve the confidence of macroscopic simulations at the continuum level of theory commonly used to develop nuclear reactor simulation codes. Ultimately, this is the simulation tool used to design, build, and test prototype reactors. Therefore, tools are needed for the key steps toward connecting the research needed to bridge the knowledge gap and to connect directly to practical simulation tools used in the licensing space of nuclear reactors. These tools need to be made broadly available to the community with the necessary computational resources, software, and data sets (see Section 7 discussion on the Virtual Reactor Simulation).

Progress in these research directions will lay down a scientific foundation for building models and performing simulations of interfacial transport phenomena of pure electrolytes at high temperatures (800 °C and potentially higher) in the presence of solid and gaseous interfaces. This class of systems applies not only to MSRs but also to metallurgy, nonaqueous materials synthesis, electrochemical

processing, and solar energy capture and conversion to solar-based fuels. Therefore, the simulation tools developed in this effort will apply broadly to various crosscutting applications of relevance to the energy and materials sectors. Specifically, these tools will enable an improved understanding of impurity interactions at interfaces, of interfacial selectivity and binding, of the volatility of dissolved species, and of the effects of confined phases. Numerous crosscutting applications will benefit from the modeling and simulation framework developed, in addition to MSR research.

The recommended computational research directions, supported and validated by experimental results, will pave the way to understanding and predicting a class of interfacial phenomena that are serious concerns in designing commercial MSRs with long operating lives (tens of years) that do not require reprocessing of the salt. For example, this work will enable the prediction of the corrosion of structural components by the salt at the inside surfaces and at the heat exchanger, enabling the design of new materials and processes to minimize corrosion and the prediction of material lifetimes under reactor conditions. The advances will enable the design of reactor materials and alloy compositions. This will accelerate the qualification of novel materials for MSR applications. Such work will improve the operando removal of fission products, xenon, krypton, iodide, and tritium. In addition, it will lead to an improved understanding of

- The loss of tritium through diffusion in the vessel walls
- Plating of surfaces by fissile products and noble metals
- The role of confinement effects on interfacial transport of the entrained gas phase
- Permeation of fission products and/or fissile species in structural materials with defects and/or grain boundaries

References

1. J. H. DeVan and R. B. Evans III. *Corrosion Behavior of Reactor Materials in Fluoride Salt Mixtures*, ORNL/TM-328, Oak Ridge National Laboratory, 1962; J. H. DeVan, *Effect of Alloying Additions on Corrosion Behavior of Nickel-Molybdenum Alloys in Fused Fluoride Mixtures*, master's thesis, University of Tennessee, August 1960 (see also reference 20).
2. F. Zaera. "Probing liquid/solid interfaces at the molecular level." *Chem. Rev.* **112**, 2920–2986, 2012.
3. T. F. Heinz, C. K. Chen, D. Ricard, and Y. R. Shen. "Spectroscopy of molecular monolayers by resonant second-harmonic generation." *Phys. Rev. Lett.* **48**(7), 478–481, 1982.
4. K. B. Eisenthal. "Equilibrium and dynamic processes at interfaces by second harmonic and sum frequency generation." *Annual Rev. Phys. Chem.* **43**(1), 627–661, 1992.
5. J. I. Dadap, J. Shan, and T. F. Heinz. "Theory of optical second-harmonic generation from a sphere of centrosymmetric material: Small-particle limit." *J. Optical Soc. Am. B* **21** (7), 1328–1347, 2004.
6. S. W. Chan, R. Barille, J. M. Nunzi, K. H. Tam, Y. H. Leung, W. K. Chan, and A. B. Djurišić. "Second harmonic generation in zinc oxide nanorods." *App. Phys. B* **84**(1–2), 351–355, 2006.
7. J. Zeng, H. M. Eckenrode, S. M. Dounce, and H.-L. Dai. "Time-resolved molecular transport across living cell membranes." *Biophys. J.* **104**(1), 139–145, 2013.
8. W. Fan, S. Zhang, N. C. Panoiu, A. Abdenour, S. Krishna, R. M. Osgood, K. J. Malloy, and S. R. J. Brueck. "Second harmonic generation from a nanopatterned isotropic nonlinear material." *Nano Lett.* **6**(5), 1027–1030, 2006.
9. P. S. Pershan and M. L. Schlossman. *Liquid Surfaces and Interfaces: Synchrotron X-ray Methods*. 1st ed., Cambridge University Press, 2012, p 334.

10. P. Fenter and N. C. Sturchio. "Mineral–water interfacial structures revealed by synchrotron x-ray scattering." *Prog. Surf. Sci.* **77**(5–8), 171–258, 2004.
11. M. K. Bera, G. Luo, M. L. Schlossman, L. Soderholm, S. Lee, and M. R. Antonio. "Erbium(III) coordination at the surface of an aqueous electrolyte." *Phys. Chem. B* **119**(28), 8734–8745, 2015.
12. G. Luo, W. Bu, M. Mihaylov, I. Kuzmenko, M. L. Schlossman, and L. Soderholm. "X-ray reflectivity reveals a nonmonotonic ion-density profile perpendicular to the surface of ErCl_3 aqueous solutions." *J. Phys. Chem. C* **117**(37), 19082–19090, 2013.
13. G. Gao, F. H. Stott, J. L. Dawson, and D. M. Farrell. "Electrochemical monitoring of high-temperature molten-salt corrosion." *Oxid. Met.* **33**, 79–94, 1990.
14. D. Ludwig, L. Olson, K. Sridharan, M. Anderson, and T. Allen. "High temperature electrochemistry of molten fluoride salt for measurement of dissolved chromium." *Corros. Eng. Sci. Technol.* **46**(4), 360–364, 2011.
15. A. G. Fernández, A. Rey, I. Lasanta, S. Mato, M. P. Brady, and F. J. Pérez. "Corrosion of alumina-forming austenitic steel in molten nitrate salts by gravimetric analysis and impedance spectroscopy." *Mater. Corros.* **65**, 267–275, 2014.
16. L. F. Epstein. "Static and dynamic corrosion and mass transfer in liquid metal systems. Liquid metals technology." *Chem. Eng. Prog. Symp. Ser.* **53**(20), 67–81, 1957.
17. R. B. Evans, III, and P. Nelson, Jr. *Corrosion in Polythermal Systems, I. Mass Transfer Limited by Surface and Interface Resistances as Compared with Sodium-Inconel Behavior*, vol. 1, ORNL-4575, Oak Ridge National Laboratory, 1971.
18. J. H. DeVan. *Effect of Alloying Additions on Corrosion Behavior of Nickel-Molybdenum Alloys in Fused Fluoride Mixtures*, ORNL/TM-2021, Oak Ridge National Laboratory, 1969.
19. W. N. Gill, R. P. Vanek, R. V. Jelink, and C. S. Grove, Jr. "Mass transfer in liquid-lithium systems." *A.I.Ch.E. J.* **6**, 139–44, 1960.
20. C. E. Sessions and J. H. DeVan. "Thermal convection loop tests of Nb-1% Zr alloy in lithium at 1200 and 1300 °C." *Nucl. Appl. and Technol.* **9**, 250–259, 1970.
21. J. J. Keyes, Jr. *Some Calculations of Diffusion Controlled Thermal Gradient Mass Transfer*, CF report 57-7-115, Oak Ridge National Laboratory, 1957.
22. D. F. Williams. *Assessment of Candidate Molten Salt Coolants for the Advanced High Temperature Reactor (AHTR)*, ORNL/TM-2006/12, Oak Ridge National Laboratory, 2006.
<http://info.ornl.gov/sites/publications/Files/Pub57476.pdf>
23. J. R. Keiser. *Status of Tellurium-Hastelloy N Studies in Molten Fluoride Salts*, ORNL-TM-6002, Oak Ridge National Laboratory, 1977.
24. P. J. A. Spencer. "A brief history of CALPHAD." *Calphad* **32**(1), 1–8, 2008.

6. FRD 5: Guiding Next-Generation Materials for Molten Salt Reactors

6.1 Background and Current Status

Structural materials (ranging from graphite to advanced metallic alloys) proposed for use in MSR will be exposed to extreme environments, including high fluences of neutrons, high operating temperatures, and corrosive environments. Challenges associated with the high temperatures will primarily be the thermal stability of such materials, such as creep strength and fracture toughness; and irradiation effects could lead to structural evolutions such as irradiation-induced swelling, creep, or embrittlement. These effects could be exacerbated by the potential dissolution of solutes into or out of the structural materials from molten salt/structural material interactions. The compositions of the melt and structural material are expected to be the dominating factors influencing degradative processes. However, salt composition is also anticipated to change as a function of time because of the formation of transuranics, fission products, and corrosion products and the introduction of contaminants. These will create a highly complex and dynamic environment that will affect the structural materials. Despite the performance already demonstrated by candidate materials, the development of advanced materials that can mitigate degradation remains a key element for the safe, successful operation of structural components in MSRs.

The stability of nickel-based alloys, as well as of steels, graphite, and ceramics, under various reactor irradiation conditions (real or simulated) has been the subject of study for decades; and the various modes of materials degradation are fairly well defined for different regimes of dose and dose rate. [1] Nevertheless, advances in the fundamental understanding of radiation damage and incremental improvements in the radiation tolerance of materials have been made, [2] and efforts to discover and design new materials with revolutionary stability under irradiation are being actively pursued. [3] Although many of these studies are not specific to MSRs, several have focused on concepts that require higher temperatures; but there have not been as many studies on radiation effects. Furthermore, there has been relatively little effort invested in designing new nickel-based alloys for radiation resistance because much of the attention of the community over the past 25 years has been on other materials systems (partly because of the observed poor phase stability of 1970s-era nickel-based superalloys after moderate irradiation doses at elevated temperatures).

Neutron irradiation effects on alloys in the temperature range of interest for MSRs are mostly cavity swelling, phase instabilities associated with radiation-induced segregation, irradiation creep, and helium embrittlement of grain boundaries. [1, 4] Neutron irradiation effects on graphite involve an initial volume shrinkage that is followed by volume expansion. [5] Unlike for metals, irradiation-induced creep is beneficial in the case of graphite because it can partially relieve some of the large stresses associated with high volumetric swelling.

6.2 Technical Challenges and Research Directions

6.2.1 Enabling Rapid Deployment of MSR Materials: Computational Challenges

MSRs represent a unique materials challenge with limited compatible materials availability and open questions regarding material lifetimes and durability. *New improved methods are needed which combine experimental characterization data with predictive modeling capabilities to develop new materials, including alloys and composites with the required radiation and chemical stability that are optimized or qualified for MSR use.* In addition, the time for new materials development needs to be greatly accelerated to meet required timelines for testing and code qualification purposes. Addressing these needs requires that an innovative combination of computational materials science and high-throughput combinatorial material testing be developed. A comprehensive set of thermochemical models and data are needed to elucidate how elemental content, reduction potential, and temperature interact to control chemical

potential, thermophysical properties, and viscosity and predict such properties at the required level of accuracy. Additional studies and computational methods are needed to increase knowledge of the microstructure-property-corrosion correlation to improve the ability to successfully develop needed material solutions for MSR. Finally, new efficient synthesis and processing methods are needed to prepare materials compatible with MSR operation.

Methods are needed to predict material behavior in complex molten salt environments. MSR-compatible materials can be designed to exhibit optimal behavior in complex molten salt environments if researchers can understand and predict the interactions at the interface between the material and the salt, as discussed in Section 5. This represents a significant challenge because the salt chemistry and properties change with time, temperature, and burnup as fission products and tritium are produced. It is imperative that these computational models be dynamic and comprehensive in treating these interface reactions. Achieving this capability will require close coupling between model development, material testing in salt systems, and fundamental investigations of salt interfaces affording an atomistic understanding of the resulting physicochemical phenomena. Such modeling capabilities are at the crossroads of traditional computational material science, computational chemistry, and experimental materials science and experimental physical chemistry. A challenge will be to understand the MSR salt chemistry evolution in parallel to material testing so that the right experimental conditions are included.

There is a need to understand and predict the microstructural evolution of materials in dynamic radiation and chemical environments. MSRs create a unique, dynamic chemical and radiation environment where any given structural material (e.g., graphite or Hastelloy N) will be undergoing simultaneous radiation damage and chemical attack while the MSR salts are undergoing radiolysis. This situation represents a significant challenge in that bulk radiation damage of structural materials is coupled to interfacial salt–material interactions. The effort to address these issues can draw on multiscale computational methods that are being developed for the study of materials operating under irradiation conditions or of plasma surface interactions. Radiation damage evolves microstructures in known ways, which include solute segregation that will compete with salt–interface reactions to produce a unique interfacial reaction zone. Ideally, this interface segregation can be optimized to provide a protected or stable interfacial region during MSR operation. Fission product uptake and diffusion, along with tritium uptake and helium production in the structural material, represent a further challenge in material design. MSR materials must be designed to mitigate high-temperature helium embrittlement and fission product corrosion. It will be necessary to predict many of these phenomena—such as helium-bubble nucleation at grain boundaries—over multiple time and length scales. For many materials, MSR operational temperatures provide relief from radiation hardening and embrittlement but push the material into a regime in which helium embrittlement can become an issue as helium is transported to grain boundaries and retained. This requires the ability to couple detailed helium trap models with helium transport and mechanics models to design materials that are resistant to helium production.

To identify and design structural materials with MSR compatibility, it is necessary to develop novel multi-resolution (in terms of physics, length scales and time scales) modeling capabilities (see Figure 29). This is a complex challenge with no suitable methods yet developed that can address these multiple time and length scales. Ab initio and classical methods will be required for structural material–salt interactions and for radiation damage resistance. The latter can be partly addressed using classical approaches coupled with cluster dynamics, spatial-dependent rate theory, kinetic Monte Carlo, and phase field or other mesoscale methods. However, as yet there are no suitable methods that can address radiation damage, helium trapping and migration, and tritium production and uptake for complex alloy systems. In any event, some starting point is required, such as Hastelloy N, for example, for alloy design. Chemical reaction models will need to be integrated with damage and deformation models to capture the range of corrosion, radiation damage, and thermal degradation that are anticipated.

The study of structural material–salt interactions will require the development of improved ab initio methods (in terms of speed) or improved classical potentials for alloy/salt systems to describe the complex corrosion and microstructural evolution that will occur at the material–salt interface. Rapid deployment approaches will rely on close coupling of computational methods and rapid characterization of materials exposed to salt test loops. However, the lack of knowledge regarding concurrent radiation damage cannot be overcome using this approach. Thus, a MSR test reactor system is required.

The paradigm envisioned in Figure 29 will enable the elucidation of the fundamental chemomechanical degradation mechanisms leading to corrosion at molten salt–structural materials interfaces, in addition to bulk radiation damage and thermomechanical degradation [6–9]. The ability to adequately simulate the response of such microstructures, to elucidate the interdependent compositional and microstructural evolution, and to gauge the associated change in thermomechanical properties in the extreme environments experienced in MSRs is crucial and necessary. Such a capability is essential not only for preventive and remedial actions to ensure safety and for performance evaluation over the lifetimes of MSR components, but also for the development of new generations of high-performance, corrosion-resistant MSR materials.

Compatibility with salt systems will require thermodynamic data for MSR salt fuels, as discussed in Section 2. The complex elemental content of a thermochemical solution model, together with those necessary for the panoply of crystalline phases that can precipitate, is unprecedented. Research is necessary to develop methods that efficiently provide accurate input data for such models and accommodate means of statistical validation. Determining the most advantageous salt composition will require the development of relationships for use in optimization algorithms.

Advanced computational methods are needed to model and predict corrosion as a function of microstructure evolution. Any framework designed to improve the modeling and prediction of the corrosion behavior in MSR materials must be based on the concurrent coupling between composition evolution, microstructure evolution, localized deformation, and damage accumulation. Atomic-/molecular-scale ab initio–based input will be necessary to calibrate this type of model and capture the adequate fundamental mechanisms influencing corrosion in MSR salts. These models can then be upscaled to phase field models, for example, to predict phase evolution and corrosion at the microscale and macroscale. The complexity envisioned for these models, however, is unprecedented and will require new methods of coarse-graining materials or upscaling to comprehensive mesoscale approaches.

Models are needed to predict materials mechanical degradation processes under MSR conditions. The mechanical properties of the materials in an MSR, such as creep strength and fracture toughness, will gradually degrade over time because of the severe environmental exposure. Although adequate models exist for such degradation mechanisms, the MSR environment is unique. For example, models for high-heat-flux materials for advanced fusion reactors are generally inadequate when plasma surface interactions must be coupled to bulk radiation damage models of hardening. Likewise, MSR corrosion models must be coupled with similar hardening models using new methods. Reactor transients, such as startup and shutdown, exacerbate this problem by introducing nonequilibrium states into the degradation mechanism space. This adds additional complexity by forcing the models to consider time-dependent stresses instead of steady state stresses. As a starting point, radiation damage models of hardening and swelling should be investigated.

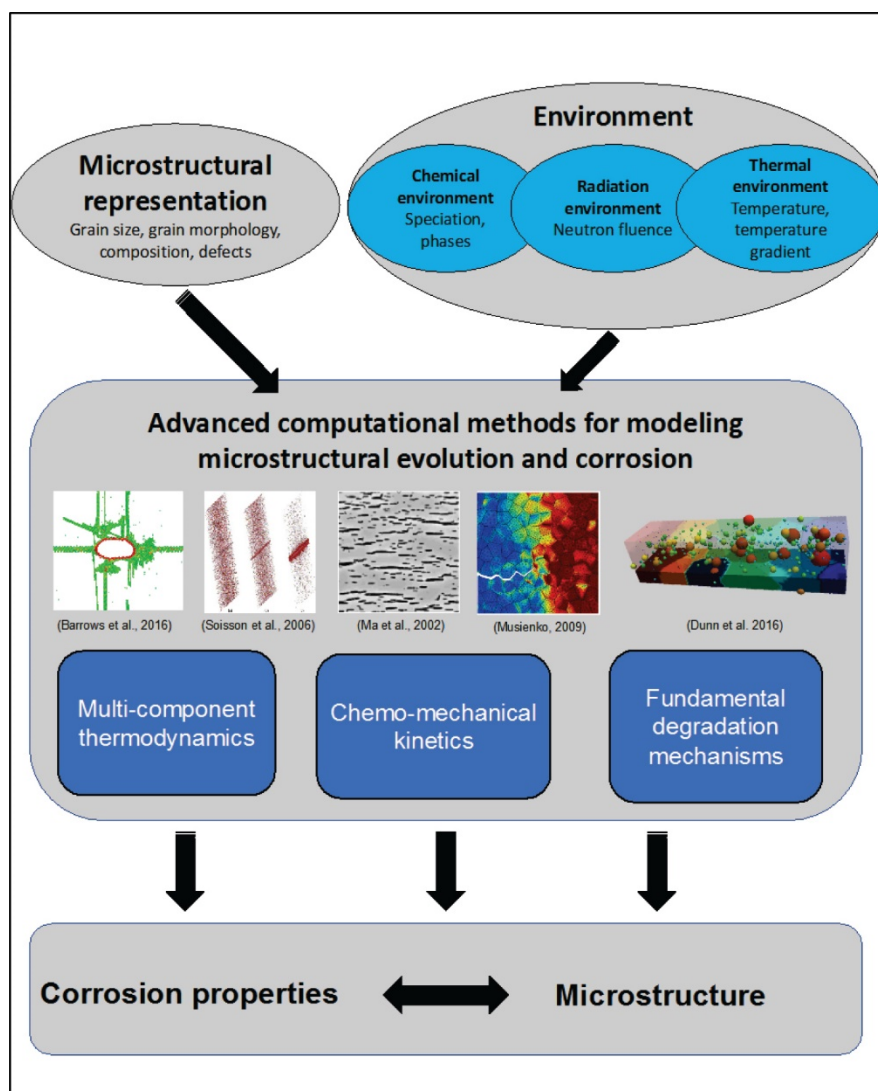

Figure 29. Example of multi-resolution modeling capabilities for microstructure evolution and corrosion. / (From left) W. Barrows, R. Dingreville, and D. Spearot. "Traction-separation relationship for hydrogen induced grain boundary embrittlement in nickel via molecular dynamics simulations." *Mater. Sci. Eng., A* 650(5), 354-364, January 2016; F. Soisson. "Kinetic Monte Carlo simulations of radiation induced segregation and precipitation." *J. Nucl. Mater.* 349, 235-250, 2006; X. Q. Ma, S. Q. Shi, C. H. Woo, and L. Q. Chen. "Simulation of γ -hydride precipitation in bi-crystalline zirconium under uniformly applied load." *Mater. Sci. Eng., A* 334, 6-10, 2002; A. Musienko and G. Cailletaud. "Simulation of inter- and transgranular crack propagation in polycrystalline aggregates due to stress corrosion cracking." *Acta Mater.* 57, 3840-3855, 2009; A. Y. Dunn. *Radiation Damage Accumulation and Associated Mechanical Hardening in Thin Films and Bulk Materials.* PhD Thesis, Georgia Institute of Technology, 2017.

Predictive multi-resolution modeling capabilities, addressing the degradation of structural materials subjected to extreme environments experienced in MSRs, will not only advance our current understanding of corrosion mechanisms due to molten salts but also create a new paradigm in the computational materials science and computational chemistry community for studying corrosion phenomena for a wide range of applications beyond MSRs. Indeed, since corrosion of materials is one of the main life-limiting processes for materials in a variety of settings, and is even more critical for MSRs, the development of improved corrosion models will greatly benefit predictive capabilities in a variety of fields. This research will greatly facilitate alloy development by advancing innovative ways of coupling advanced characterization methods and data sets with advanced computational models of salt/material interactions and bulk materials degradation models. The advanced chemistry approaches developed will have wide-ranging impacts in a variety of material-centric fields.

The ability to predict material properties under extreme conditions is essential to understanding how materials degrade and fail. The ability to accurately predict material lifetimes provides needed safety information as well as a foundation for the design of improved materials. The rational design of materials using these models will allow new and accelerated approaches for material deployment in extreme environments, such as MSRs, by increasing materials testing throughput. Tailored and optimized materials will enable MSRs and other technologies required for future energy production. These methods could impact materials design efforts for other advanced nuclear systems or other high-temperature material systems.

6.2.2 Guiding Experimental Exploration of Advanced “Super” Materials

Although much work has focused on the quantification of current materials for use in MSRs, there exists a need for the development of new materials to meet the increased demands of advanced reactor concepts. The development of INOR-8 (Hastelloy N) after the ARE and its deployment in the MSRE serves as an example of a successful development of a new material for use in molten salt environments. Although reactor vendors are currently pursuing designs that incorporate alloys from the current ASME Boiler Pressure Vessel Code, there is a tremendous opportunity to take advantage of innovative advanced materials or “super materials.” Although code-qualifying a new alloy or material can take over a decade and cost tens of millions of dollars, the benefits in terms of operational life, maintenance costs, and safety could be significant. Nevertheless, most companies are not willing to investigate non-code materials because of the time required and the cost.

Current materials, including Hastelloy N, cannot effectively address the higher temperatures and more aggressive radiation and chemical environments presented by some advanced MSR concepts. Proposed reactors with core temperatures above 900 °C and radiation damage over 1000 displacements per atom (dpa) represent pathways to energy independence through the use of tailored thermochemical processes (e.g., thermochemical H₂ cycles), increased power-cycle thermal efficiency, and added utility from enabling flexible fissile fuel options. To achieve these goals requires developing new classes of super materials that can withstand the more aggressive conditions. Materials must be sufficiently thermodynamically stable in the coolant/fuel (i.e., molten salt), accommodate imposed mechanical loads, and be immune to significant dimensional and property changes from radiation damage over the design lifetime of the reactor system. Performance requirements must be balanced with practical considerations such as availability, affordability, fabricability, and manufacturability and acceptance by regulatory bodies.

High temperatures are typically associated with loss of strength, creep, and higher corrosion rates. High dpa from exposure to neutron flux is associated with hardening, void swelling, and helium embrittlement. In MSRs, the challenge is compounded by temperature gradient, mass transfer, corrosion, and reactions with fission products, i.e., tellurium. The materials design space for MSRs includes the use of metals, ceramics, coatings, claddings, multilayer and nanostructured materials and, as necessary, composites. This variety of materials needs to be explored comprehensively to discover the super materials needed for maximum MSR performance. There is also a need for selective design of materials to ensure lifetime requirements are met. These requirements include maintaining material strength at temperatures in excess of 750 °C without suffering cracks or embrittlement, resisting corrosion, and also maintaining size and shape within the design specifications.

The development cycle for new structural materials can be shortened through the application of modern materials science computational tools, as discussed earlier. Computational studies can be performed to down-select favorable chemical compositions from thermodynamic and kinetic stabilities; predict properties; and simulate component lifetimes through known/verified mechanisms of time-dependent mechanical, corrosion, and radiation behavior before trial materials are manufactured and properties

screened (see the sidebar “Optimizing Superalloys” on p. 65). This approach is an improvement over the traditional development path of fabricating trial materials from a large chemistry matrix for screening tests, and it has been successfully employed in a number of DOE–NE programs. Improvements in the accuracy of these tools and the development of new computational tools and databases to cover additional material behavioral responses would further shorten the development cycle. When the justification exists to actually start materials testing, there is also the possibility of much smaller alloy synthesis routes compared with the traditional large “heats” of years past.

It also needs to be recognized that some of the components in an MSR will have different requirements at different locations, leading to more severe restrictions on material development. This issue could be addressed by developing innovative advanced manufacturing methods, such as additive manufacturing, that would allow tailoring of properties via the adjustment of compositions throughout the structural component. In addition, innovative methods of materials development can have a significant scientific impact on how material design is performed. This impact may lead to a deeper understanding of the underlying scientific principles of how materials behave in extreme environments and how they are best tailored for use in high-temperature, molten salts environments that are subjected to high radiation levels. Furthermore, the current limitations in understanding the joining of dissimilar materials, such as joining ceramics to metal seals, must be addressed; doing so would be an enabling technology.

6.2.3 Advancing Code Qualification of New Materials

A significant hurdle for the development of MSR structural materials is code qualification. The design of high-temperature coolant boundary structural components for deployment in nuclear reactor systems is required to follow the construction rules of the ASME Boiler and Pressure Vessel Code (Section III, Division 5). The qualification of new metallic materials requires multiple steps, including composition selection, processing and heat-treating steps, and finding a vendor willing to produce large quantities of the material.

After development, ASME-based qualification of the metal includes long-time scale testing at operational temperatures (anywhere from 1/5 to 1/3 of the expected usage lifetime), preferred examples of the material applicability in other non-nuclear extreme environments, corrosion testing, and irradiation-induced changes to the physical/thermal/mechanical properties. Many of these steps are not easily accelerated, since the mechanisms controlling the changes may be not be the same at different conditions. Testing at operational temperatures could easily require 6–10 years of continuous testing for a component for which a 30 year usage lifetime is desired. In many cases, such a long period of testing is cost-prohibitive; therefore, materials used in other industries often are leveraged toward ASME code validation.

Study of the changes caused by the irradiation environment in the reactor also is very time-intensive. In the current materials test reactors (High Flux Isotope Reactor and Advanced Test Reactor), lifetime damage accumulation can be sped up by a factor of 5–10. As a result, a 30 year lifetime component requires a minimum of 3–6 years of irradiation time alone (while the development and construction of the irradiation capsules and/or the post-irradiation examination of the properties and microstructure could expand the testing program to 7–10 years). Corrosion studies in the MSR environment will also require experiments to study the base metal–salt interaction at high temperature, as well as exposure to the salt in an irradiation environment, since the chemistry of the salt will be continuously changing as fission occurs. These experiments are technically challenging and require complex experimental setups in addition to long times to perform the tests. These issues highlight the need for innovative experimental test protocols and analytical methods to efficiently gather the required information for code qualification.

The qualification of nonmetallic materials requires a similar development process to that for metallic materials. The primary difference is that qualification for nonstructural materials usually does not include long-term testing at operational temperatures (not required for ASME code qualification). But long-term studies of irradiation-induced changes and corrosion behavior are still critical knowledge requirements for in-reactor use.

Optimizing Superalloys

Nickel-based superalloys have an exceptional combination of high-temperature mechanical properties, primarily as a result of the formation of coherent nano-precipitates of the Ni₃Al L12-type in the nickel-based face-centered-cubic matrix. However, achieving similar microstructure and performance in other low-cost materials continues to be a challenge. Today it is feasible to use a modern accelerated approach to high-temperature structural alloy development based on atomic-level control of interfaces. Predictive design of favorable properties in materials under extremes requires that the microstructural interfaces, such as grain and phase boundaries, be stable under high temperature and stress. While phase diagrams for stability of individual phases are often well known, an integrated understanding of the interfacial stability in the presence of individual or multiple atomic species is still needed. Microalloying elements that maximize stress and temperature resistance by computing the energetics of higher mobility interfaces are an aspect that needs to be verified and refined through experiments. Large-scale, high-throughput ab initio calculations can be the basis for simulating interfacial evolution at high stress and homologous temperature (ratio of temperature and absolute melting point). A suite of experimental characterization techniques—such as atom probe tomography, transmission electron microscopy, neutron diffraction, and mechanical characterization—can be used to help verify the computational predictions. Such models and experimental results can form a scientific framework for understanding and controlling interfacial stability in superalloys, thereby dramatically accelerating the design of next-generation, advanced alloys optimized for molten salt reactors.

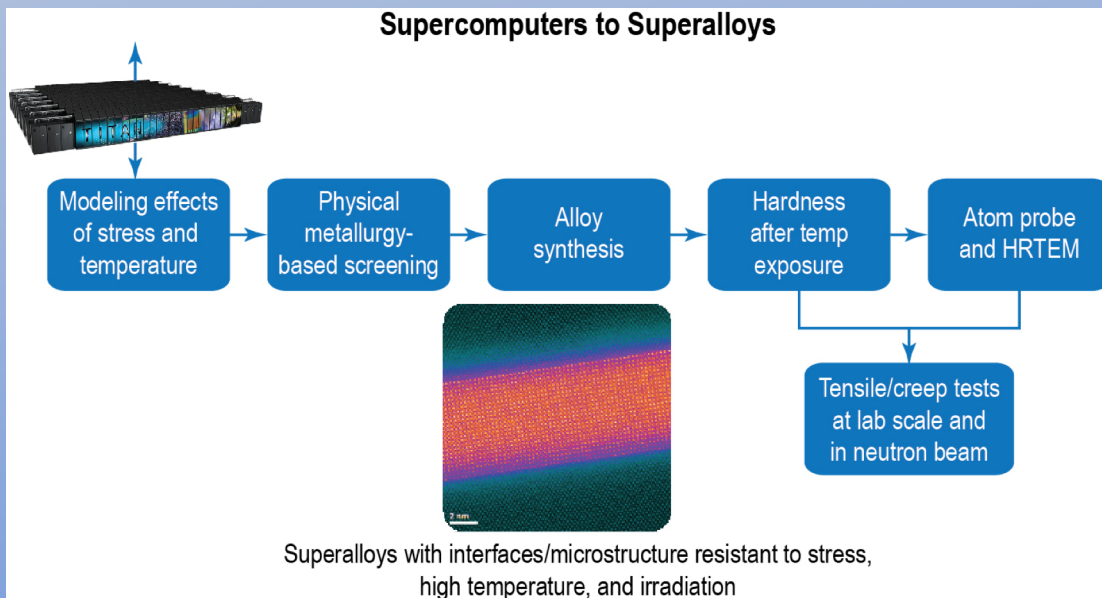

References

1. S. J. Zinkle and J. T. Busby. “Structural materials for fission and fusion energy.” *Mater. Today* **12**, 12–19, 2009; R. M. Boothby. “Radiation effects in nickel-based alloys,” in ed. R.J.M. Konings *Comprehensive Nuclear Materials*, vol. 4. Elsevier, Amsterdam, 2012. pp. 123–150; A. F. Rowcliffe, L. K. Mansur, D. T. Hoelzer, and R. K. Nanstad. “Perspectives on radiation effects in nickel-base alloys for applications in advanced reactors.” *J. Nucl. Mater.* **392**, 341–352, 2009.
2. S. J. Zinkle and L. L. Snead. “Designing radiation resistance in materials for fusion energy.” *Annu. Rev. Mater. Res.* **44**, 241–267, 2014.
3. J. B. Roberto and T. Diaz de la Rubia. *Basic Research Needs for Advanced Nuclear Energy Systems*. Office of Basic Energy Sciences, US Department of Energy, 2006; Y. W. Zhang, G. M. Stocks, K. Jin, C. Y. Lu, H. B. Bei, B. C. Sales, L. M. Wang, L. K. Beland, R. E. Stoller, G. D. Samolyuk, et al. “Influence of chemical disorder on energy dissipation and defect evolution in concentrated solid solution alloys.” *Nature Comm.* **6**, 8736–8739, 2015; G. R. Odette, “Recent progress in developing and qualifying nanostructured ferritic alloys for advanced fission and fusion applications.” *JOM* **66**, 2427–2441, 2014.
4. T. R. Allen, M. Anderson, R. Ballinger, T. D. Burchell, E. D. Blandford, D. Clark, W. R. Corwin, G. Flanagan, C. W. Forsberg, P. Hosemann, et al. “Fluoride-salt cooled, High-temperature Reactor (FHR) Materials, Fuels and Components White Paper,” UCBTH-12-003, Department of Nuclear Engineering, University of California, Berkeley, California, 2013.
5. L. L. Snead, T. D. Burchell, and Y. Katoh. “Swelling of nuclear graphite and high-quality carbon fiber composite under very high irradiation temperature,” *J. Nucl. Mater.* **381**, 55–61, 2008; L.L. Snead. “Fusion energy applications,” in ed. T. D. Burchell, *Carbon Materials for Advanced Technologies*. Pergamon, New York, 1999, pp. 389–427.
6. W. Barrows, R. Dingreville, and D. Spearot. “Traction-separation relationships for hydrogen induced grain boundary embrittlement in nickel via molecular dynamics simulations.” *Mater. Sci. and Eng., A* **560**(5), 354–364, 2016.
7. F. Soisson. “Kinetic Monte Carlo simulations of radiation induced segregation and precipitation.” *J. Nucl. Mater.* **349**(3), 235–250, 2006.
8. A. Musienko and G. Cailletaud. “Simulation of inter-and transgranular crack propagation in polycrystalline aggregates due to stress corrosion cracking.” *Acta Mater.* **57**(13), 3840–3855, 2009.
9. A. Dunn, R. Dingreville, E. Martínez, and L. Capolungo. “Synchronous parallel spatially resolved stochastic cluster dynamics.” *Comput. Mater. Sci.* **120**, 43–52, 2016.

7. FRD 6: Creating a Virtual Reactor Simulation

7.1 Background and Current Status

MSR technology development requires the use of modeling and simulation to understand the behavior of the reactor throughout its lifetime, including during normal operation, operational transients (such as startup and shutdown), and accident conditions. To accurately predict reactor conditions, an appropriately validated reactor system simulator is needed which incorporates the major physical phenomena that drive design and operational challenges at a suitable level of fidelity and accuracy. A virtual reactor (VR) simulator needs to include the reactor core and primary heat exchanger, plus related support systems, such as off-gas and online salt processing and refueling. The VR simulator should describe phenomena including neutron transport, thermal hydraulics, isotopic transmutation of the fuel, thermochemical properties of the fuel salt, and resulting corrosion effects, while also possessing sufficient fidelity to address material transport due to corrosion and thermal gradient redeposition. The VR would also define the source term for the MSR. This effort represents a significant scientific challenge because of the coupling of transport codes with thermodynamic models and material–salt chemistries, but it can build off the foundational studies outlined in the previous sections of this report.

7.2 Technical Challenge and Research Directions

7.2.1 Creating a Virtual Reactor Simulation

The challenges associated with the deployment of MSR technology are summarized by Briant and Weinberg [1]:

Two very different schools of reactor design have emerged since the first reactors were built. One approach, exemplified by solid fuel reactors, holds that a reactor is basically a mechanical plant; the ultimate rationalization is to be sought in simplifying the heat transfer machinery. The other approach, exemplified by liquid fuel reactors, holds that a reactor is basically a chemical plant; the ultimate rationalization is to be sought in simplifying the handling and reprocessing of fuel.

The existing assumptions and simplifications in current modeling and simulation tools are specialized for solid-fuel systems; adapting these tools for liquid fuel systems requires significant effort, particularly in the coupling to the molten salt chemical analysis, as previously discussed. *The major scientific challenge is to develop an accurate simulation of a MSR, including flowing fuel, neutronics, transport, chemistry, and in situ continuous processing and refueling.* The model would need to be dynamic, which represents a grand challenge because of the complex material properties and transport. The simulator needs to include the primary loop, i.e., the reactor core and the primary heat exchanger, and related support systems such as off-gas and online salt processing (if needed) and refueling. The phenomena described by the simulator must include neutron transport, thermal hydraulics, isotopic transmutation of the fuel, thermochemical properties of the fuel salt, and corrosion effects. The simulator must also be validated with well-quantified uncertainties, since the nuclear industry and regulating authorities will need such a tool to ensure the efficiency and safety of this new technology.

The neutronic response of the reactor depends on salt properties such as density and viscosity, which will evolve with depletion of the fuel. Changes in fuel composition may also change the preferred speciation of elements, the liquidus temperature of the melt, and surface-salt interactions. Additionally, tritium produced by ternary fissions or reaction with salt constituents will easily permeate hot metal alloys and needs to be taken into account. All these phenomena are coupled together in a MSR system and need to be accurately described by the simulator.

A transformational advancement of a VR is a salt thermochemical transport modeling and simulation capability. While this is important for solid-fueled MSR designs, a more extensive contribution will be made for liquid-fueled systems. The salt thermochemical transport will focus on describing the redox reactions in the flowing salt and reactivity leading to corrosion, in addition to radiolysis and chemical speciation in the liquid and gas phases. Online monitoring can provide input and validation of these computational predictions. The monitoring will be augmented by considerations of reactions with impurities, and of the nucleation and growth of particulates, which have ramifications for performance, safety, and off-gas operation.

The molten salt VR must be able to determine the fluence on the core structural material, the neutron reflector, and the vessel wall, which can be used along with the temperature values and salt composition to determine the lifetimes of these components. Additionally, these data will enable analysis of tritium production and the migration through the primary loop. It can also be used to optimize alternative salts that would reduce tritium production while maintaining good nuclear and chemical properties. The VR must also be able to couple to power plant system models to investigate transient and safety analysis of these reactors.

The development of a molten salt VR can leverage existing neutronic and thermal hydraulic capabilities, but it will need to be extended to capture the complexities of MSRs. A specific challenge that will be addressed is the “delayed neutron precursor drift” phenomenon, which results in the birth of delayed neutrons (i.e., the decay of precursors) in a different location from the fission that produces the precursor. In solid-fuel designs, the fission products are stagnant; but with a liquid-fuel design, they are carried away with the fluid fuel flow. To capture this effect, delayed neutron precursor groups need to be explicitly modeled even during steady state operation. The standard delayed neutron precursor models can be adapted by adding in a convection term. Since the change in the core flow speed changes the effective delayed neutron fraction in the core, this feature is critical for modeling power transients during accidents such as a pump trip. In addition to the delayed neutron precursors, there are other elements that require special treatment because of the flowing fuel, such as xenon, which is a neutron poison. Also, the redistribution of heat coming from nuclear decay must be properly dispersed throughout the system.

Several key advancements are needed to capture the thermal hydraulic performance of MSRs. The natural first extension is to add the capability for direct fluid heating as the dominant heat source. Another key feature is the ability to transport nuclides throughout the system. This capability needs to be extended to capture multiple species at the same time, which will lead to a coupled set of species transport equations to account for the interaction between species. An additional complication is the thermophysical properties variation with concentration of species; since fission products will be generated pointwise, and convected nonuniformly, the implementations of such variations must be considered. In addition, models or correlations for dynamic phase diagrams for estimating thermophysical properties and melting point will be required.

The addition of mass transport and thermochemistry requires information from both the heat and the momentum fields of the bulk fluid. Additionally, the reactor physics component should provide a radiation environment that will continually create fission events and transmute the components of the salt as they are irradiated. It is necessary to account for these effects in considering the thermochemical reactions in the reactor. The mass transport and thermochemistry will also impact the reactor physics and the thermalhydraulic solution. The reactor physics model will need the detailed distribution of salt components throughout the core. For short-lived fission products, there may be a non-trivial gradient in the concentration during standard reactor operation that must be accounted for. Likewise, the properties of the molten salt—density, viscosity, thermal conductivity, and specific heat—will change as the salt changes. Both feedback mechanisms must be accounted for. Figure 30 shows the three major components of a VR and the data that are needed between the various components.

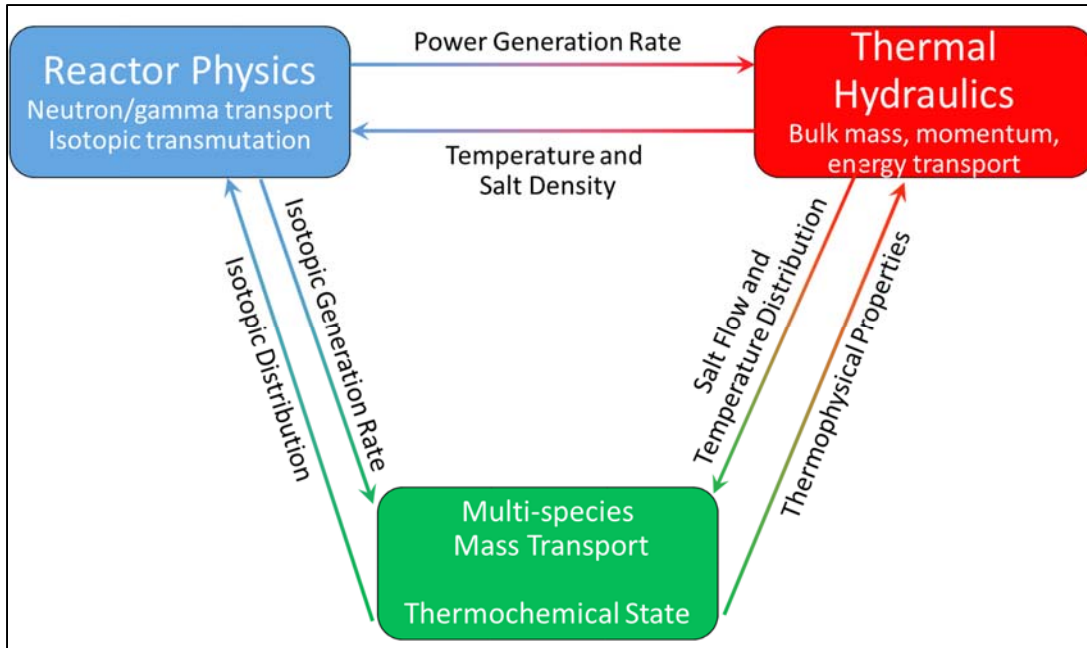

Figure 30. A schematic showing the three major components of a virtual reactor simulation and the data that are needed between the various components. | *Image courtesy of Oak Ridge National Laboratory*

The virtual simulator code will need validation and uncertainty quantification (VUQ). The VUQ will require sets of separate effects and integral effect tests to quantify uncertainty for each phenomenon and each of the implemented multiphysics components. Data are available from international molten-salt loop tests that can be used for validation. Additionally, the MSR VR should be used to simulate the ORNL MSRE operation and demonstrate the capability developed to measured data from an operating reactor. The MSRE operation represents the only data available in the world for a well-characterized operating MSR and will be crucial for system-level validation.

Two sets of critical experiments were performed at MSRE. The first was performed using ^{235}U fuel loading. [2] The data measured include the critical position as well as the measurement of various reactivity coefficients, including temperature, enrichment, differential control rod worth, and the effects of fuel circulation. The second was performed using ^{233}U fuel. [3] Very similar measurements were performed with the different driver fuel. Additionally, the dynamic behavior of the MSRE was studied in detail for these different fuels, [4-6] and its fuel flow behavior characterized. [7]

It is recognized that an MSR is a tightly coupled dynamic multiphysics system consisting of neutronics, thermal hydraulics, fission product generation and transport, and the chemistry of constituents. The thermophysical properties will be changing as the fuel moves through the system. The solubility of solutes will change as new fission products are added. Developing a VR simulator will require specification of figure of merit or safety parameters and identification and ranking of phenomena with respect to the figure of merit. Then each physics will have its own constitutive relationships that may come from experiments or first principles. We anticipate that advanced 3-dimensional meshing algorithms will need to be developed to adequately handle these demands, with perhaps a phase field model handling the thermochemistry coupled to other transport models.

Overall, the capabilities of a virtual MSR simulator with a tightly coupled model with fuel flow, salt chemistry, surface corrosion, neutron transport, and thermal hydraulics would enable advanced design and analysis of complex fluid-fueled systems. This would allow for the understanding of operational issues including fuel cycle analysis, fuel loading analysis, prediction of waste forms and quantities, and

prediction of chemical processes required to reduce chemistry issues. The virtual model would also define the source term for the MSR. In addition, this capability will allow for the assessment of new molten salts and new reactor designs.

Another application of this simulation capability would be in the design of irradiation test stands and the analysis of results from irradiation experiments that will be needed for the development of MSR technology. Nearly all of the phenomena that need to be simulated in a reactor can be probed to some extent in irradiation tests of increasing complexity, and this simulation capability can be of great value in designing the irradiation experiments.

References

1. R. C. Briant and A. Weinberg. "Molten fluorides as power reactor fuels." *Nucl. Sci. Engr.* **2**, 797–803, 1957.
2. B. E. Prince, S. J. Ball, J. R. Engel, P. N. Haubenreich, and T. W. Kerlin. *Zero-Power Physics Experiments on the Molten Salt Reactor Experiment*, ORNL-4233, Oak Ridge National Laboratory, February 1968.
3. J. R. Engel and B. E. Prince. *Zero-Power Experiments with ^{233}U in the MSRE*, ORNL-TM-3963, Oak Ridge National Laboratory, December 1972.
4. T. W. Kerlin, S. J. Ball, R. C. Steffy, and M. R. Buckner. "Experiences with dynamic testing methods at the Molten-Salt Reactor Experiment." *Nucle. Appl. Tech.* **10**, 2, February 1971.
5. T. W. Kerlin and S. J. Ball. *Experimental Dynamic Analysis of the MSRE*, ORNL-TM-1647, Oak Ridge National Laboratory, October 1966.
6. R. C. Steffy. *Experimental Dynamic Analysis of the MSRE with ^{233}U Fuel*, ORNL-TM-2997, Oak Ridge National Laboratory, April 1970.
7. R. J. Kedl. *Fluid Dynamic Studies of the MSRE Core*, ORNL-TM-3229, Oak Ridge National Laboratory, November 1970.

APPENDIX A: WORKSHOP RESOURCE DOCUMENT

Publicly available at <https://info.ornl.gov/sites/publications/Files/Pub73652.pdf> and included in the following pages.

TECHNOLOGY AND APPLIED R&D NEEDS FOR
Molten Salt Chemistry

Resource Document for Workshop

DOCUMENT AVAILABILITY

Reports produced after January 1, 1996, are generally available free via US Department of Energy (DOE) SciTech Connect.

Website <http://www.osti.gov/scitech/>

Reports produced before January 1, 1996, may be purchased by members of the public from the following source:

National Technical Information Service
5285 Port Royal Road
Springfield, VA 22161
Telephone 703-605-6000 (1-800-553-6847)
TDD 703-487-4639
Fax 703-605-6900
E-mail info@ntis.gov
Website <http://classic.ntis.gov/>

Reports are available to DOE employees, DOE contractors, Energy Technology Data Exchange representatives, and International Nuclear Information System representatives from the following source:

Office of Scientific and Technical Information
PO Box 62
Oak Ridge, TN 37831
Telephone 865-576-8401
Fax 865-576-5728
E-mail reports@osti.gov
Website <http://www.osti.gov/contact.html>

This report was prepared as an account of work sponsored by an agency of the United States Government. Neither the United States Government nor any agency thereof, nor any of their employees, makes any warranty, express or implied, or assumes any legal liability or responsibility for the accuracy, completeness, or usefulness of any information, apparatus, product, or process disclosed, or represents that its use would not infringe privately owned rights. Reference herein to any specific commercial product, process, or service by trade name, trademark, manufacturer, or otherwise, does not necessarily constitute or imply its endorsement, recommendation, or favoring by the United States Government or any agency thereof. The views and opinions of authors expressed herein do not necessarily state or reflect those of the United States Government or any agency thereof.

**TECHNOLOGY AND APPLIED R&D NEEDS
FOR MOLTEN SALT CHEMISTRY**

**Resource Document for the
Molten Salt Chemistry Workshop:**

Innovative Approaches to Accelerate Molten Salt Reactor
Technologies Deployment

Prepared by David F. Williams
Oak Ridge National Laboratory

Date Published: April 2017

Prepared by
OAK RIDGE NATIONAL LABORATORY
Oak Ridge, TN 37831-6283
managed by
UT-BATTELLE, LLC
for the
US DEPARTMENT OF ENERGY
under contract DE-AC05-00OR22725

CONTENTS

CONTENTS.....	iii
FIGURES.....	v
TABLES.....	v
ACRONYMS.....	vii
1. INTRODUCTION.....	1
2. MOLTEN SALT REACTOR CHEMISTRIES.....	3
2.1 PHYSICAL CHEMISTRY CHALLENGES.....	4
2.1.1 Reasoning Framework for Salt Choices.....	4
2.1.2 Phase Diagrams and Solubility Behavior.....	6
2.1.3 Thermophysical and Transport Properties.....	7
2.1.4 Modeling and Simulation.....	9
2.2 ANALYTICAL CHEMISTRY CHALLENGES (including measurement instruments and online sensors).....	9
2.3 IRRADIATION AND FISSION PRODUCT CHEMISTRY CHALLENGES.....	11
2.3.1 Molten Salt Fission Product Chemistry.....	11
2.3.2 Barren-Salt Activation Product Chemistry: Tritium and Sulfur.....	14
2.3.3 Solid Salt Irradiation Behavior.....	15
2.4 MATERIALS COMPATIBILITY CHALLENGES.....	18
2.4.1 Corrosion.....	18
2.4.2 Irradiation (Neutron) Damage Limits.....	21
3. TECHNOLOGY AND APPLIED R&D NEEDS.....	23
4. REFERENCES.....	25
APPENDIX A. THUMBNAIL SUMMARIES OF REACTOR CONCEPTS UNDER CONSIDERATION BY MSR TECHNICAL WORKING GROUP.....	A-1
APPENDIX B. 1969 MOLTEN SALT REACTOR EXPERIMENT VIDEO.....	B-1
APPENDIX C. MOLTEN SALT REACTOR EXCERPTS FROM “AN ACCOUNT OF ORNL’S 13 RESEARCH REACTORS” BY MURRAY ROSENTHAL.....	C-1

FIGURES

Figure 1. Functional categories of molten salts for reactor applications.	3
Figure 2. Early MSR program approach to screening and justifying candidate MSR salts.	4
Figure 3. Effect of cationic radius on solubility of tri-fluorides in molten fluorides at 550°C [6].	6
Figure 4. Trivalent solubility effects in plutonium and minor actinides fueled fluoride salts [6].	6
Figure 5. Three-dimensional model of LiF-BeF ₂ -ZrF ₄ phase diagram [11].	8
Figure 6. Electroanalytical results from measurement on MSRE fuel [22].	10
Figure 7. MSRE-era electroanalytical and spectrophotometric apparatuses [22].	11
Figure 8. Fission product classes identified during MSRE operation highlighted as groups in the periodic chart (below) and the fission-yield curve (above).	13
Figure 9. Exemplar short-lived fission products that change solubility behavior during decay in a fuel circuit (typically < 1 minute salt recirculation residence time).	14
Figure 10. MSRE salt phase segregation on cooling [52].	17
Figure 11. Temperature-gradient mass transfer [53].	20
Figure 12. Persistent salt corrosion as a temperature-gradient-driven redox cycle [54].	20
Figure 13. Dual challenges of higher temperatures and displacements for MSR in-core structural materials [61].	22

TABLES

Table 1. Qualitative assessment of salt coolant properties database and predictive methods [12]	9
Table C-1. ARE parameters	C-7
Table C-2. MSRE parameters	C-9

ACRONYMS

ANP	Aircraft Nuclear Propulsion Program
ARE	Aircraft Reactor Experiment (fuel salt composition: 53.1-40.7-6.2 mol% NaF-ZrF ₄ -UF ₄)
MSBR	Molten Salt Breeder Reactor (fuel salt composition: 71.7-16-12-0.3 mol% ⁷ LiF-BeF ₂ -ThF ₄ -UF ₄)
MSR	Molten Salt Reactor
MSRE	Molten Salt Reactor Experiment (fuel salt composition: 65-29.1-5-0.9 mol% ⁷ LiF-BeF ₂ -ZrF ₄ -UF ₄)
ORNL	Oak Ridge National Laboratory
PMA	plutonium and minor actinides
R&D	research and development

1. INTRODUCTION

The Department of Energy (DOE) Office of Nuclear Energy is sponsoring the Molten Salt Chemistry Workshop (Innovative Approaches to Accelerate Molten Salt Reactor [MSR] Technologies Deployment) to be held at Oak Ridge National Laboratory (ORNL) April 10–12, 2017. This workshop is intended to identify science-based, technology-driven research opportunities to facilitate and accelerate MSR technologies development.

Highlighted areas will include physical chemistry, irradiation and fission product chemistry, analytical chemistry (including instruments and in-line sensors), and materials compatibility.

The goals of the workshop are to identify (1) research topics that address both short-term technology showstoppers and long-term grand challenges that may enable revolutionary changes in molten salt technologies and (2) a set of priority research directions that may accelerate molten salt technology development and deployment. The workshop discussion will be focused on high-risk/high-payoff research in molten salt chemistry and salt chemical properties and reactions that affect the application of molten salt for advanced nuclear systems.

This resource document was prepared by the author in consultation with subject matter experts from other national laboratories. In particular, the author acknowledges review and suggestions by Bill Del Cul and Sheng Dai (ORNL), Guy Frederickson (Idaho National Laboratory), and Mark Williamson and Sam Sham (Argonne National Laboratory). A draft of this report was circulated on March 20 to those registered for the workshop for comment (comment deadline was March 29 for revision) and all comments were addressed. It was released in final form on April 3.

This document provides information from the scientific research community that underpins MSR technologies. Emphasis is placed on identifying fundamental knowledge gaps and potential solutions.

2. MOLTEN SALT REACTOR CHEMISTRIES

New molten salt nuclear reactor concepts have recently garnered significant attention in the United States and other countries. For this workshop, the following systems are emphasized:

- Fast-spectrum chloride fuel salts containing NaCl, sometimes other chloride diluents, and high concentrations of (U/Pu)Cl₃
- Fluoride fuel salts (primarily for thermal spectrum applications)
 - Similar to Molten Salt Reactor Experiment (MSRE)/Molten Salt Breeder Reactor (MSBR) salts containing ⁷LiF and/or NaF and BeF₂ combined with low concentrations (< 5 mol%) of UF₄/PuF₃ and sometimes containing larger concentrations of ThF₄ (~10 mol %)
 - Containing ⁷LiF and/or NaF and high concentrations of UF₄/ThF₄ (near eutectic: 25–30 mol% actinide)
- Primary and secondary coolant salts
 - Fluoride salt primary and secondary coolant candidates (e.g., LiF/NaF-BeF₂, FLiNaK, NaF-ZrF₄) and sometimes other types of low-pressure secondary coolants (chlorides, nitrates, liquid metals)

Seven of the eight concepts under consideration by the MSR Technical Working Group in conjunction with the Gateway for Innovation in Nuclear initiative are fluid-fueled reactors, and one is for a solid-fueled salt-cooled reactor. Figure 1 provides a functional diagram for these systems and Appendix A provides a thumbnail description of each one.

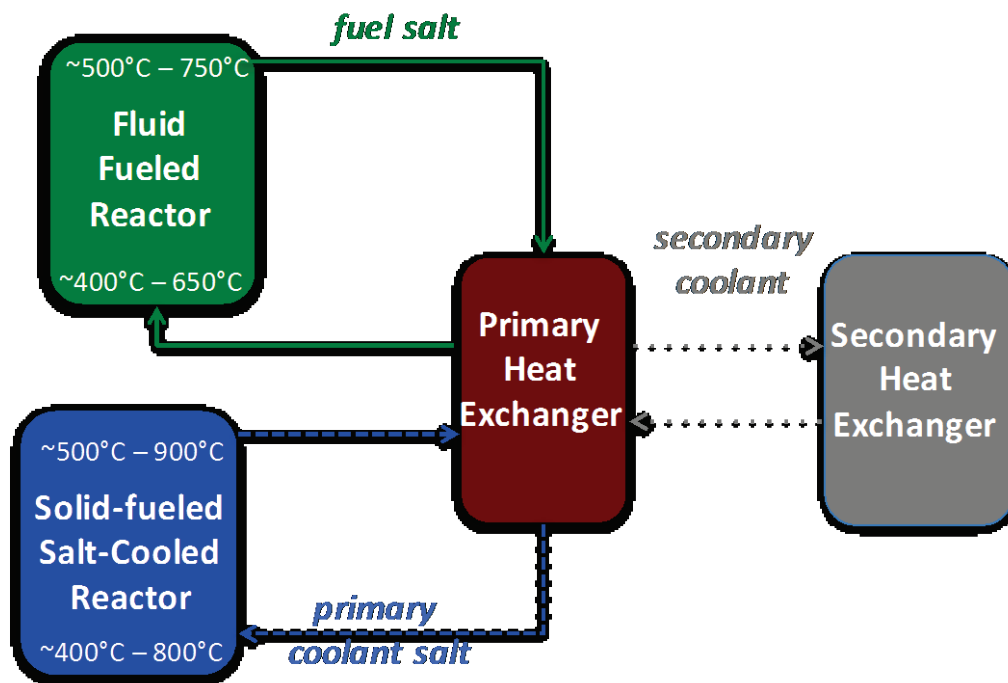

Figure 1. Functional categories of molten salts for reactor applications.

2.1 PHYSICAL CHEMISTRY CHALLENGES

2.1.1 Reasoning Framework for Salt Choices

Salt systems selected for investigation must be justified to ensure that they are viable based on our current understanding of their physics and chemistry, they are good research and development (R&D) targets, and there are no better choices. Sometimes lost in the wealth of recent literature is the underpinning of reasoning that motivated and sustained the early MSR programs. This traditional approach defined requirements for the application at hand to downselect salt systems based on their nuclear and chemical behavior, as outlined in Figure 2 [1–4].

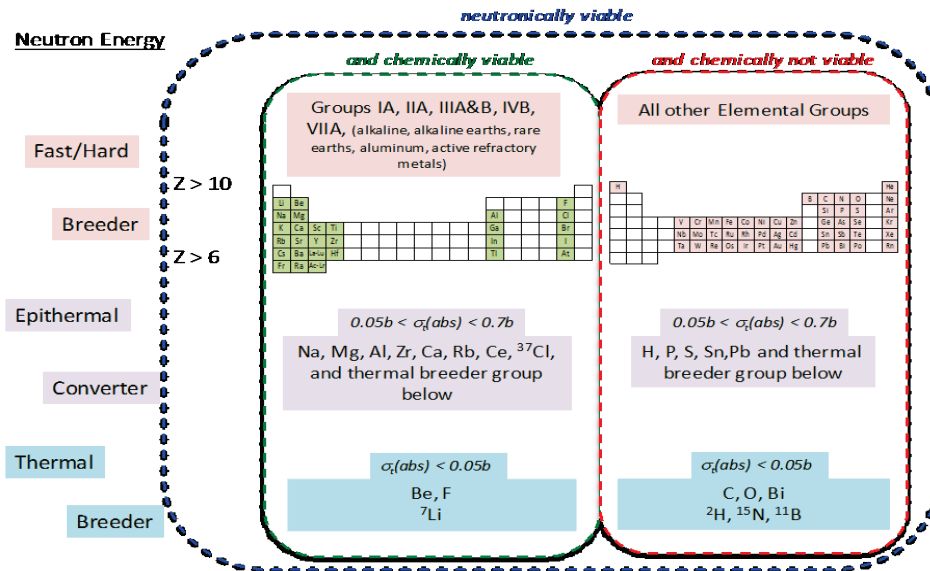

Figure 2. Early MSR program approach to screening and justifying candidate MSR salts.

At the top level, neutronics (parasitic neutron absorption and moderating properties) limit the choices of nuclides that can be considered, in combination with limits associated with the mission of the reactor (breeder, burner, converter) and neutron energies in the system. Figure 2 highlights the neutronic constraints that strongly limit the choice of constituents for thermal and epithermal reactors and the chemical constraints that exert a controlling influence on all reactor applications as a result of the following requirements [1]:

The fuel must dissolve more than the critical concentration of fissionable material at temperatures safely below the heat exchanger exit temperature. It must consist of elements of low capture cross sections for neutrons of the energy spectrum of the design chosen. The mixture must be thermally stable and must possess low vapor pressure over the temperature range proposed for operation. The fuel mixture must possess heat transfer and hydrodynamic properties adequate for its service as heat exchange fluid without excessive power required for circulation. It must be relatively non-corrosive to some (otherwise suitable) material, presumably a metal, of construction. The fuel must be stable to reactor radiation, must be able to survive fission of uranium or other fissionable material and must tolerate fission product accumulation without deterioration of its useful properties [1].

Early references explain why non-halide fluid-fueled systems (systems containing H, B, C, N, O, Bi) were rejected for large-scale high-temperature, low-pressure applications based on one of the chemical criteria listed in the previous paragraph [1–4].

The requirement that fuel salt be compatible with a container material places the most wide-ranging constraint on the choice of salt constituents because it requires the cationic constituents of the salt to be composed of relatively active, electropositive elements (fluoride compound free energies of formation > 95 kcal/mol-F), whereas the container material must be composed of elements that are relatively noble in comparison (fluoride compound free energies of formation < 75 kcal/mol-F) [3]. This requirement eliminates the middle of the periodic chart for consideration as salt constituents and the periphery of the periodic chart for consideration as alloy constituents (only a small region in the center is suitable for metallic alloys). Nonmetallic materials (e.g., ceramics, composite materials) can also be compatible with high-temperature salt—for example, graphite is known to be fully compatible with molten halides to very high temperatures. Although nonmetallic materials have been used and may find service as core internals, there is currently no joining and fabrication technology to support and deploy these as the container material for many of the complex components that are in contact with salt.

The neutronic requirements for a primary coolant are distinctly different from those for a fuel salt, and initial studies indicate that low-neutron-absorbing salts are necessary to obtain negative void and temperature coefficients [5]. Secondary coolant salts have no formal neutronic requirements, but consideration is typically given to the ability to recover/remediate leakage of secondary coolant into primary coolant or fuel salt. The chemical requirements for primary and secondary coolant salts are similar to those for fuel salts.

2.1.2 Phase Diagrams and Solubility Behavior

Knowledge of phase diagrams is an essential requirement. Maintaining fissile and fertile material in solution is a fundamental requirement for solution reactors, so knowing the phase diagram behavior of actinides is of primary importance. For some MSR concepts, very high burnups and accumulation of fission products are foreseen, and research must account for how this increasing concentration of fission/activation products affects the solubility of fissile and fertile materials and the melting point of the salt. Trivalent elements often play a key role in determining melting point increases and solubility limits as actinides and fission products accumulate in a fuel salt, as shown in Figures 3 and 4 [6].

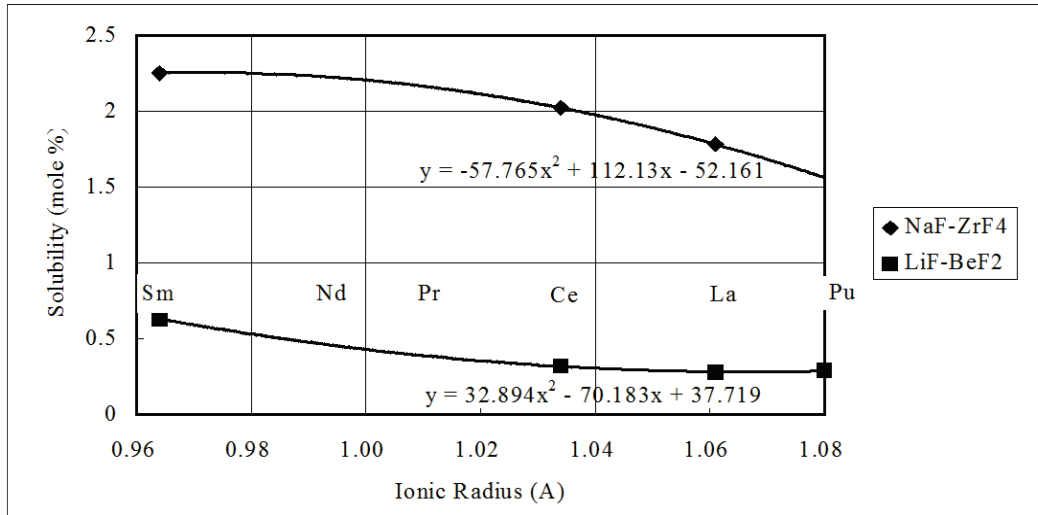

Figure 3. Effect of cationic radius on solubility of tri-fluorides in molten fluorides at 550°C [6].

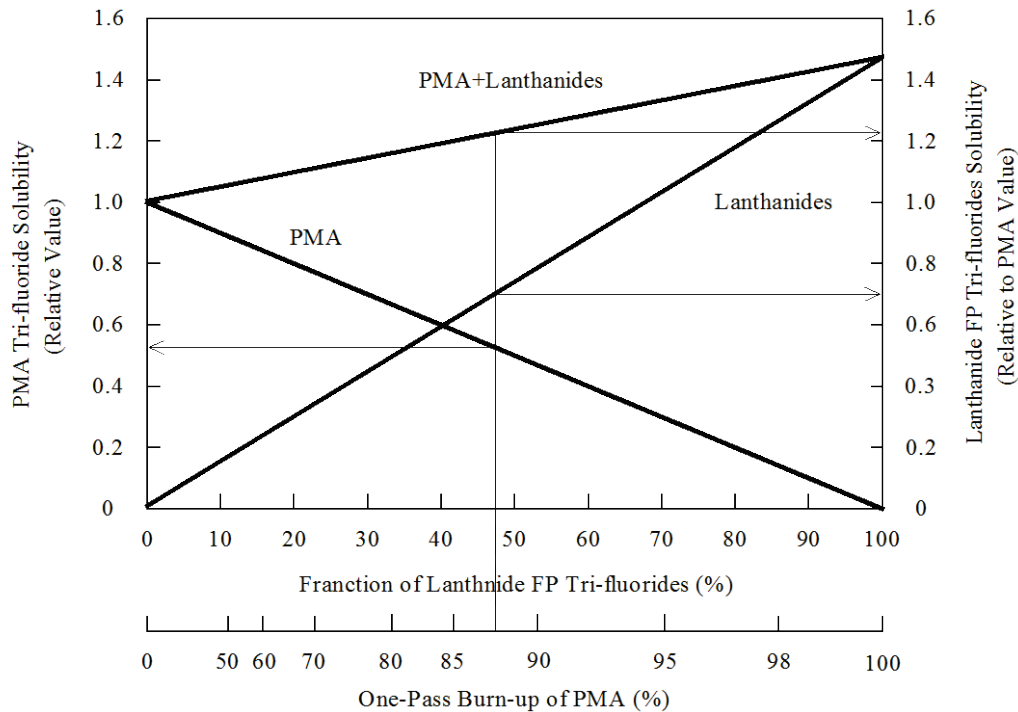

Figure 4. Trivalent solubility effects in plutonium and minor actinides fueled fluoride salts [6].

Sometimes unrecognized is the interplay of oxidation-reduction (“redox”) equilibria and phase diagram behavior. Given the recent interest in salts with high actinide concentrations (up to and exceeding 30 mol%), the distribution of species between trivalent and tetravalent states according to the redox condition of the salt will need to be accounted for. For uranium-containing salts to be noncorrosive toward container materials, a small fraction of uranium must be trivalent for fluoride salts (UF_3) and tetravalent (UCl_4) in chlorides. For fluorides, there is a demonstrated benefit to maintaining salts at more reducing conditions to reduce corrosion and tellurium-attack [7–8]. Yet these very same conditions tend to increase the trivalent uranium fluoride content of the salt and could reduce the trivalent solubility margins (trivalents often exhibit an approximate “group solubility”). The complementary perspective is that trivalent actinide chlorides are the majority species in chlorides, and the tetravalent solubility associated with UCl_4 and tetravalent fission products will need to be accounted for, as well as the native volatility of UCl_4 . Increases in the trivalent content of the fuel salts will occur as a result of accumulation of activation and rare earths fission products and will likely increase the melting point of the salt because of a group trivalent solubility effect.

The preceding discussion emphasizes minimizing oxidative corrosion by maintaining the salt in a reduced state. However, salts kept at very reduced conditions can promote other types of interactions with container materials and reactor internals, such as alloying, carburization, and wetting interactions that can cause unwanted intrusion of salt into the pores of core internals (e.g., graphite pores). This type of interaction between the salt and its container material imposes a limit on how reducing the salt can be maintained.

Bounds on avoiding both oxidative corrosion and unwanted reductive interactions define a suitable redox window. Bounds on the redox window for the MSRE and MSBR fluoride salts were defined (~0.5%–15% UF_3/UF_4) [9], but those for the desirable redox windows for other fluorides and chlorides have not yet been established [10].

2.1.3 Thermophysical and Transport Properties

A significant number of molten salt properties have been measured and correlated and this knowledge should be harvested and used for present needs. However, not all properties are known or can be accurately estimated, especially those of new salt compositions proposed for reactor application. A few of the salts under consideration (e.g., $2\text{LiF}-\text{BeF}_2$) have a deep properties database (Figure 5); but for many, we are pushing the boundaries of our knowledge.

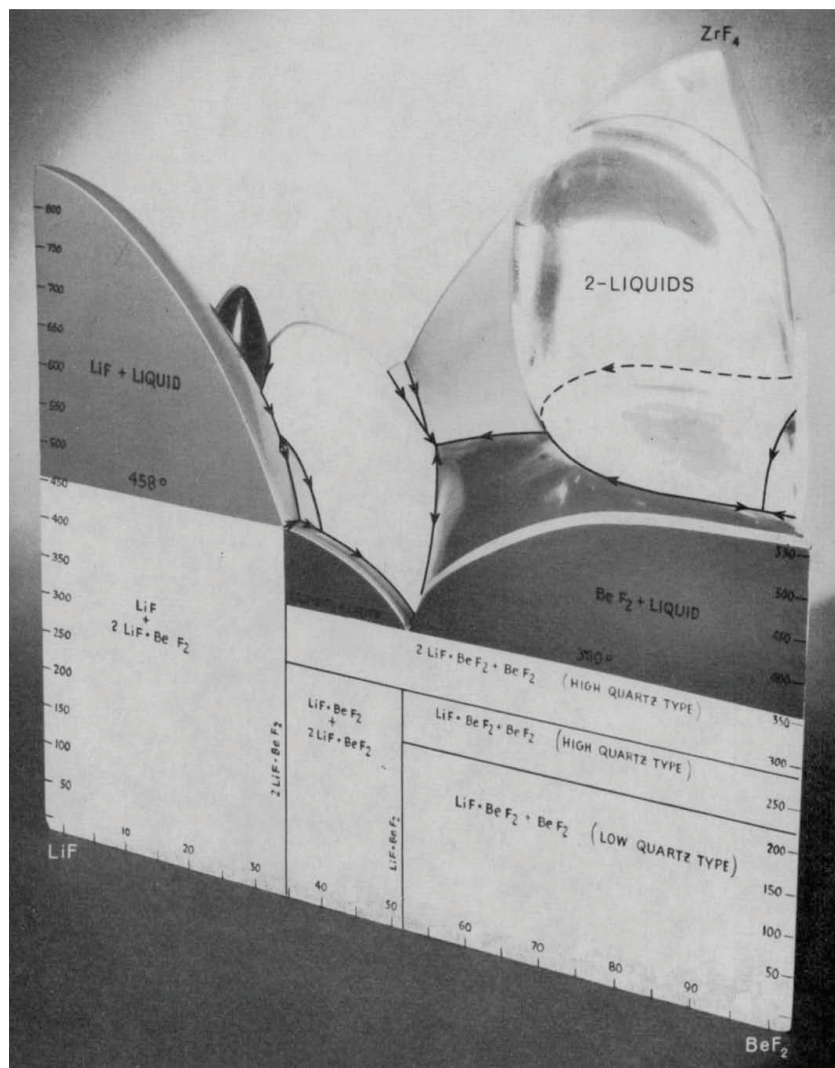

Figure 5. Three-dimensional model of LiF-BeF₂-ZrF₄ phase diagram. *Source:* Reprinted from J. Nucl. Mater. 27(2), R. E. Thoma, H. Insley, H. A. Friedman, and G. M. Herbert, “Equilibrium phase diagram of the lithium fluoride-beryllium fluoride-zirconium fluoride system,” 166–180, 1968, with permission from Elsevier.

For some properties (density, heat capacity), simple methods exist for correlating or obtaining an approximate estimate of the true value, but for others (melting point, vapor pressure, viscosity, and thermal conductivity), measurements are usually needed to proceed with confidence.

Phase transition thermodynamics govern melting point and species volatility (vapor pressure) and reflect the behavior of a number of complex solution species. A priori predictions of these phase transitions are difficult without some data to determine what species and interactions exist. Interaction parameters based on lower order datasets (e.g., binary mixtures) can sometimes lead to reasonable predictions for higher order datasets (e.g., ternary mixtures).

Viscosity and thermal conductivity are defined by constitutive equations for momentum and heat transfer and depend upon the structure of the molten salt in a complex manner. For thermal conductivity, trustworthy measurements are scarce because it is difficult to measure this property

at elevated temperatures in a manner that factors out the parallel heat transfer modes of thermal radiation and convection. The transmissive and absorptive properties of the salt for thermal radiation will be needed for detailed heat transfer analyses. With the exception of thermal conductivity, all salt properties have demonstrated measurement methods that can be refined to obtain high accuracy and reproducibility. A summary of these points is provided in Table 1, which is from a previous study.

Table 1. Qualitative assessment of salt coolant properties database and predictive methods [12]

Prediction method \ Measurement	Accurate	Approximate	Difficult to predict
accurate	<i>Density</i>		<i>Melting point</i> <i>Vapor pressure</i> <i>Viscosity</i>
database is deficient*		<i>Heat capacity</i>	
poor database difficult to measure			<i>Thermal conductivity</i>

* Better measurement methods exist since the database was populated.

2.1.4 Modeling and Simulation

There is a significant opportunity to extend the knowledge base and strategically fill database gaps by using modeling and simulation to improve our ability to understand and correlate salt properties of all types. The understanding of property trends with compositional changes can be of great value in guiding any measurement campaign.

Phase Transitions/Diagrams

It is typically acknowledged that ab initio prediction of phase transitions/equilibria is more difficult than the prediction of stationary thermodynamic properties. A thermodynamic framework that makes use of experimental data on simpler systems is the current method in use [13]. However, recent progress in predicting phase transitions in molecular crystals suggests a similar approach might be developed for ionic crystals [14–15].

Thermophysical and Transport Properties (density, heat capacity, viscosity, thermal conductivity)

Atomistic models, and molecular dynamic simulations in particular, have recently been applied with success to correlating molten salt physical properties [16–21]. The trend of property changes with composition is sometimes revealed more accurately than the absolute value of the property itself; but in some cases, remarkably accurate property estimates can be derived from reliable atomistic interaction parameters.

2.2 ANALYTICAL CHEMISTRY CHALLENGES (INCLUDING MEASUREMENT INSTRUMENTS AND ONLINE SENSORS)

Traditional destructive chemical and isotopic analysis methods were successfully applied to irradiated and unirradiated molten salt samples during the Aircraft Nuclear Propulsion (ANP), MSRE, and MSBR efforts. Although improvements in some archival sample analyses are likely

needed, the primary R&D need is for short-turnaround (“nearly instantaneous”) feedback from nondestructive online analytical methods. Ongoing surveillance of the salt chemistry is required to ensure the reactor is operating within safe bounds with regard to corrosion and other unwanted chemical interactions; in this regard, measurement of the U^{3+}/U^{4+} ratio and level of dissolved alloy constituents (e.g., Cr, Fe, Ni) is the first priority. Electroanalytical and spectrophotometric methods were tested in the lab during the MSRE and MSBR efforts on unirradiated and irradiated MSRE salts, and their viability and value was firmly established. Refinement of these techniques for application (and durability) in the complex MSR solution and its accompanying high-radiation field was recognized as a significant R&D challenge. Examples of the results and apparatus used at the end of the MSRE/MSBR program are depicted in Figures 6 and 7.

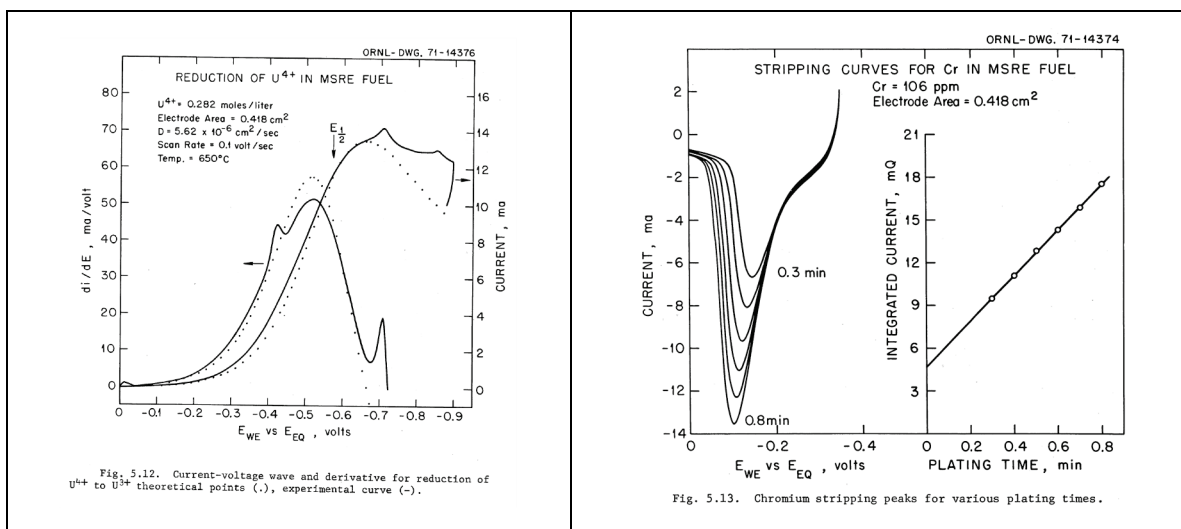

Figure 6. Electroanalytical results from measurement on MSRE fuel [22].

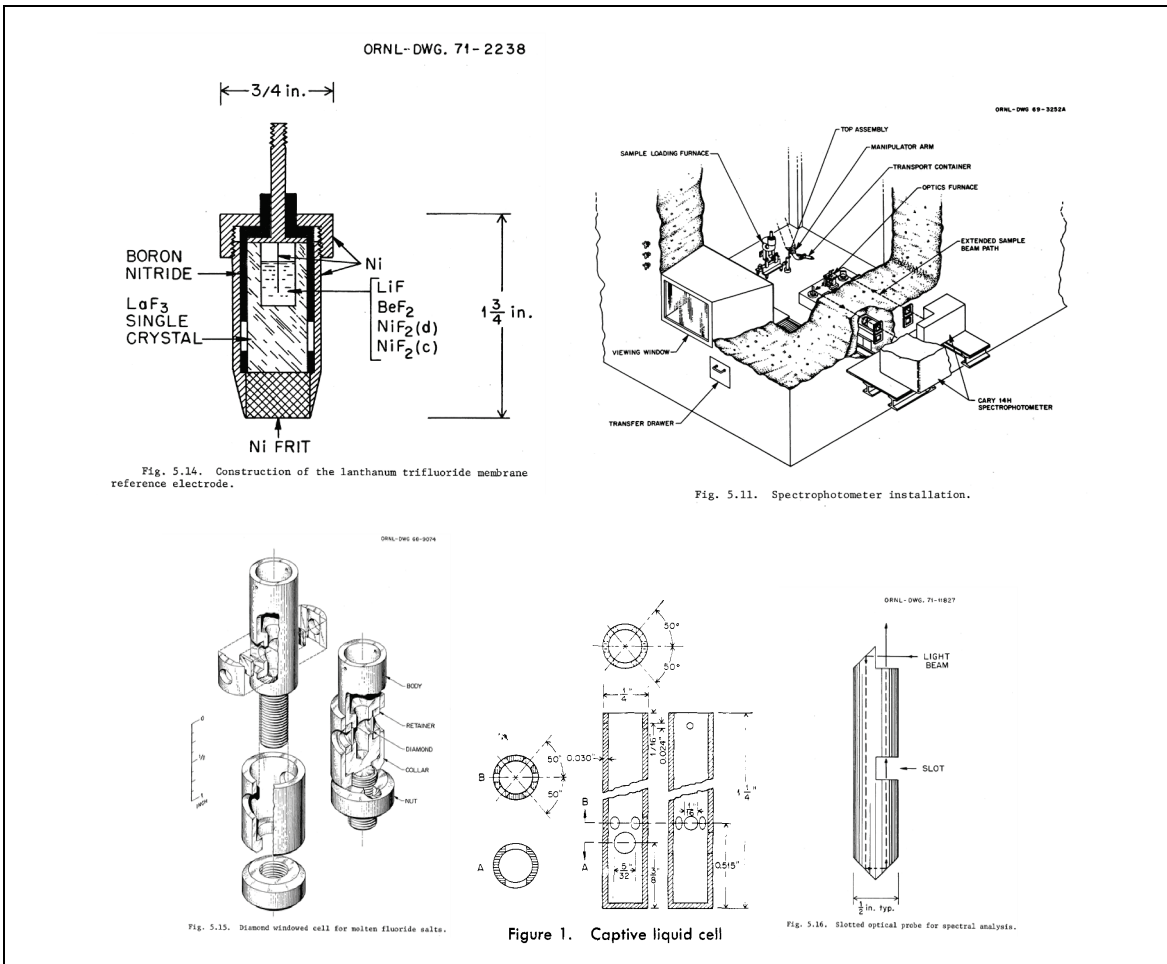

Figure 7. MSRE-era electroanalytical and spectrophotometric apparatuses [22].

Spectrophotometry provides fundamental and specific information about species in solution and has the potential to determine absolute values of most actinide constituents. At the end of the MSBR program, higher spatial- and energy-resolution gamma radiation detection methods were being tested. With the advent of much more capable radiation detection and imaging methods in the intervening years, it is likely that both assay and surveillance by radiation detection methods will find new applications. Since the end of the MSBR program, development of molten salt electroanalytical and spectrophotometric methods and apparatuses has continued [23–29].

2.3 IRRADIATION AND FISSION PRODUCT CHEMISTRY CHALLENGES

2.3.1 Molten Salt Fission Product Chemistry

Noble gas behavior was a focus of early fission product studies because these neutron poisons controlled breeding gain and could produce strong reactivity effects in thermal reactors. The solubility of noble gases in fluoride salts was found to be very low; therefore, the near-complete removal of these elements was achieved by use of low-porosity moderator graphite, non-wetting salts, and straightforward methods to strip the noble gas from the salt.

For the other fission products, it is important to understand where they go and how they behave to provide a radiation map to support dose control, maintenance, and accident-mitigation/response, as well as to design features into the plant and components to account for their behavior and manage their disposition. The detailed chemical behavior of many fission products remained uncertain at the end of the MSBR program (1976), and not much more is known today. What we know about their behavior in the MSRE salt is summarized in Figure 8 [30], and we believe other fluoride and chloride salts follow similar patterns of behavior. There is also a body of evidence developed for fission product behavior during pyroprocessing of solid fuels using chlorides and fluorides, but the redox conditions applied and salt compositions used are significantly different from those under consideration as fluid fuels. The short-lived isotope effects described below are largely absent from the pyroprocessing experience.

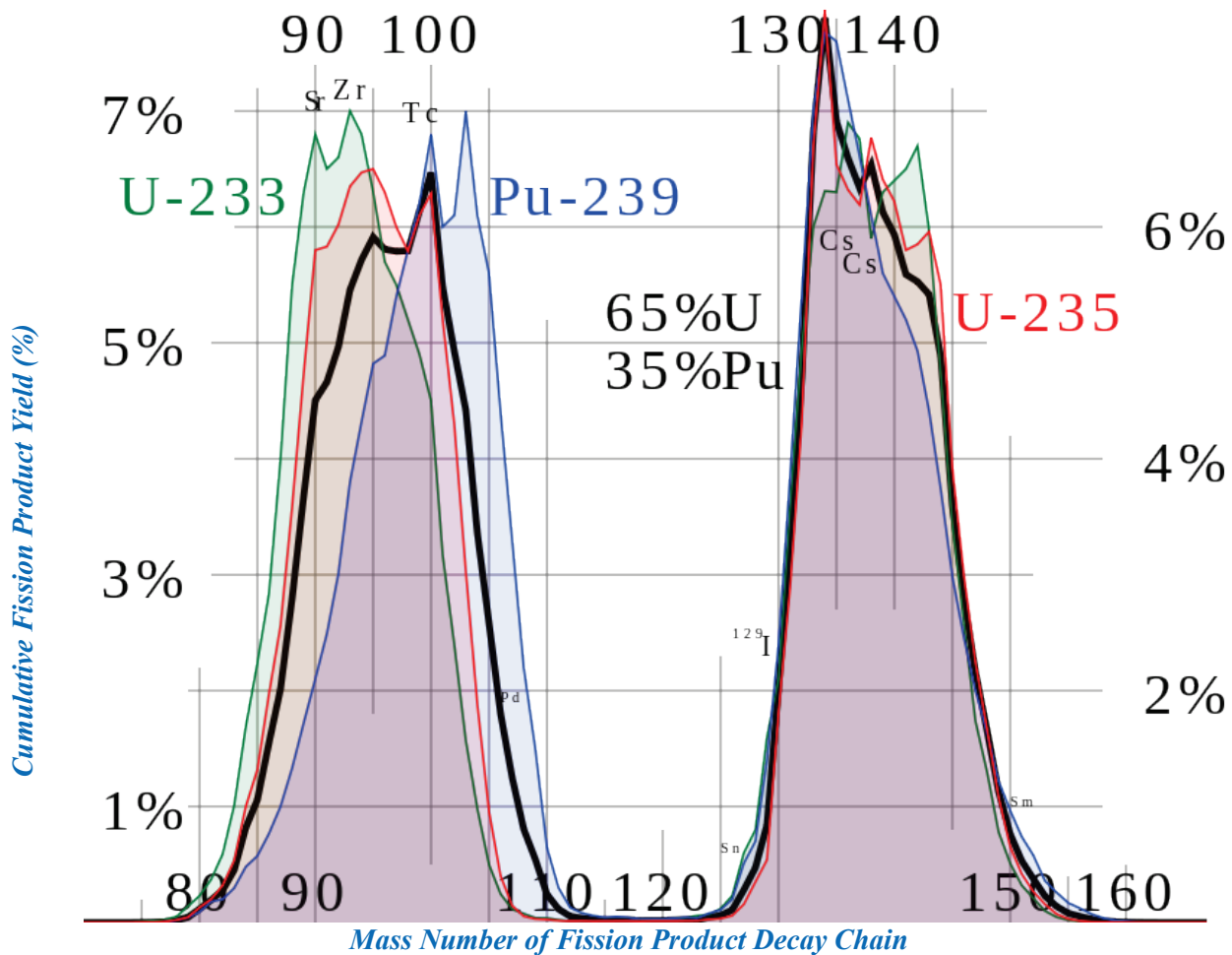

gas		soluble										insoluble					soluble-gas-soluble				
H																	He				
Li	Be											B	C	N	O	F	Ne				
Na	Mg											Al	Si	P	S	Cl	Ar				
K	Ca	Sc	Ti	V	Cr	Mn	Fe	Co	Ni	Cu	Zn	Ga	Ge	As	Se	Br	Kr				
Rb	Sr	Y	Zr	Nb	Mo	Tc	Ru	Rh	Pd	Ag	Cd	In	Sn	Sb	Te	I	Xe				
Cs	Ba	La-Lu	Hf	Ta	W	Re	Os	Ir	Pt	Au	Hg	Tl	Pb	Bi	Po	At	Rn				
Fr	Ra	Ac-Lr																			

always soluble	sometimes soluble	insoluble	gaseous
----------------	-------------------	-----------	---------

Figure 8. Fission product classes identified during MSRE operation highlighted as groups in the periodic chart (*below*) and the fission-yield curve (*above*). (Upper graphic source: “Fission product yield,” Wikipedia, https://en.wikipedia.org/wiki/Fission_product_yield.)

Four classes of fission products were identified based on the MSRE experience: gaseous species, soluble species, insoluble species, and sometimes-soluble species. The noble gases comprise the gaseous species. The IA (alkali), IIA (alkaline earth), IIIA&B (rare earths and Al-group), IVB (active refractories), and VIIB (halogens) comprise the soluble species. The transition metals between Nb and Te comprise the insoluble “noble metal group.” The Nb, Te, and Zn periodic columns comprise the sometimes-soluble species—their behavior changing with the redox state of the salt.

How these insoluble and sometimes-soluble species transition from birth at an atomic level to an insoluble phase or deposit is not completely understood, and several hypotheses still compete to explain what occurs [31]. Although a major fraction of the fission products end up as salt-soluble species (including iodine), the decay behavior of the fission product chain is quite complex in many cases and can result in partition of short-lived species before the longer-lived isotope emerges. This situation occurs for many of the noble metal fission products and for the key isotopes of ^{137}Cs , ^{99}Mo , and ^{131}I , as shown in Figure 9.

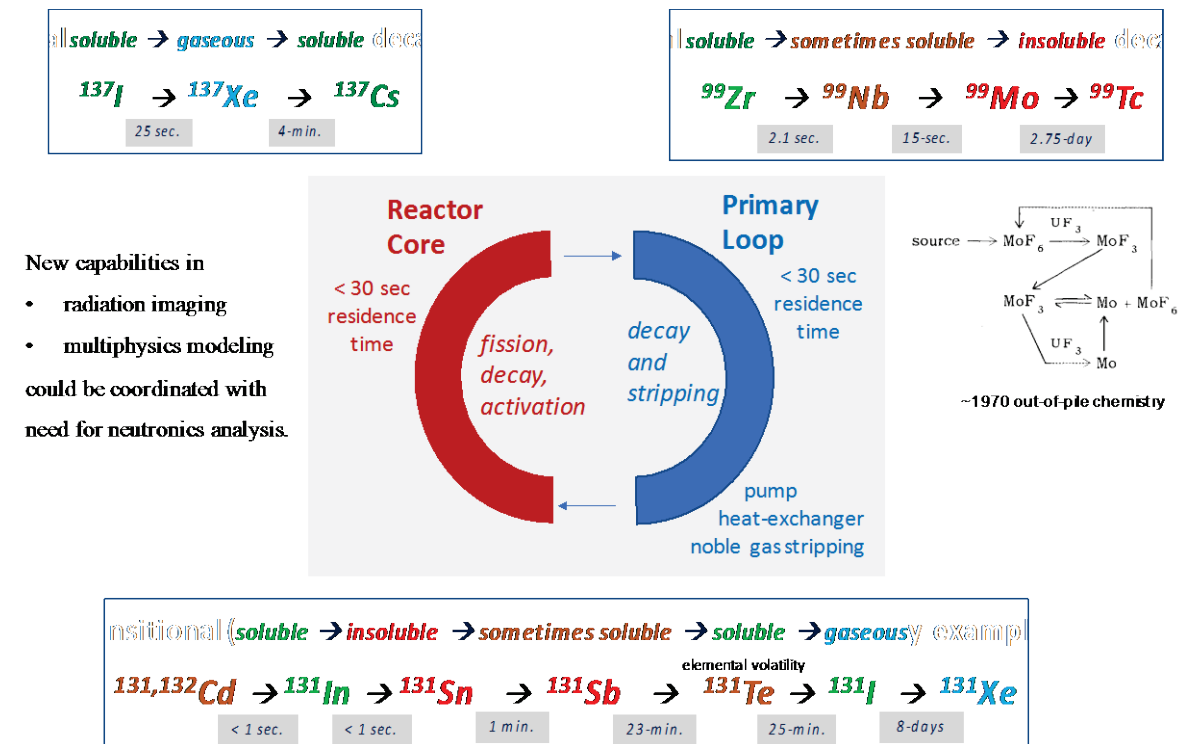

Figure 9. Exemplar short-lived fission products that change solubility behavior during decay in a fuel circuit (typically < 1 minute salt recirculation residence time).

2.3.2 Barren-Salt Activation Product Chemistry: Tritium and Sulfur

Tritium is produced in MSR by both ternary fission and a number of light-element neutron reactions. With the exception of its production from the irradiation of lithium, the amounts produced are similar to those produced in high-temperature reactors and light water reactors; and its mobility through alloys at high temperatures is a problem that is shared with gas-cooled high-temperature reactors. It is the use of lithium (and even lithium highly enriched in ^7Li) in the fuel

salt or primary coolant that is attended by large amounts of tritium production (rivaling or exceeding the amounts produced in heavy-water reactors) [32–34].

Although tritium is not particularly long lived and has only weak beta-particle emissions, because of its mobility, it has the potential to create large amounts of low-level radioactive waste if it reaches water in the environment or in the balance of plant. It must also be controlled to levels safe for workers and the public. There is a wealth of information on the technology used to control hydrogen and tritium transport, and many types of solutions can be envisioned, including various barriers and trapping approaches. Because of the fluxing property of halide salts, it is very unlikely that any type of film on salt-wetted alloy surfaces could serve as a barrier to tritium.

During the operation of the MSRE, a significant fraction of the tritium produced permeated the primary systems and was not controlled or trapped by the off-gas systems [35]. As part of the post-MSRE studies, a fluoroborate coolant-salt-trapping modality was identified for the MSBR fluoroborate secondary coolant [35–36]. Modeling and experimental studies on the behavior of tritium in MSR systems have continued since the MSBR-era studies [37–39]. It was also proposed that an oxygen-containing secondary salt, such as a nitrate mixture, would be able to chemically trap tritium, as was demonstrated with the oxygen moiety in fluoroborates. The ability to manipulate the chemistry in other fluoride or chloride salts (such as the behavior of trace oxygen levels as dissolved or undissolved components) to provide tritium trapping is not known.

In chloride fuel salts not heavily enriched in ^{37}Cl , the activation of ^{35}Cl will produce significant quantities of ^{36}S by (n,p) activation. Taube predicted sulfur levels in the thousands of ppm at steady state in a molten chloride fast reactor composed of unenriched chlorides, and it is clear that this production has both a redox effect and potentially a chemical corrosive/reactive effect (akin to that associated with its periodic chart neighbor tellurium in group 6A) [40–44].

2.3.3 Solid Salt Irradiation Behavior

The behavior of solid salt during interim or long-term storage is an important issue because solid halide salts can sustain considerable radiation damage and chemical change upon irradiation by the alpha, beta, and gamma radiation produced by the decay of dissolved fission and activation products. The production of metal centers and reactive halogens (e.g., F_2) within the salt was observed in discharged irradiation capsules and the stored MSRE fuel salt [45–46]. The importance of distinguishing solid-salt irradiation effects from molten-salt irradiation effects was clearly demonstrated during the testing that led up to the design and operation of the MSRE [47].

Testing of fuel and coolant fluoride salts by in-reactor irradiation confirmed that molten salt is largely immune to irradiation damage—any primary radiolytic event is rapidly reversed by recombination. No materials damage or chemical effects of beta, gamma, neutron, or alpha radiation (or fission fragments) were observed in molten fluorides even when very high (> 1 kw/cc) in-reactor fission power densities were applied. This testing also revealed that if the MSRE salt was allowed to freeze and cool to temperatures below 200°C, significant radiolysis and chemical change occurred very quickly, driven by the intense radiation associated with the

short-lived decay of fission products. Thus any study of irradiated salts must account for this factor, and the domain where radiolysis occurs must be understood for any new salts.

Molten chloride salts have not seen the intense in-pile power densities proposed for molten salt fast reactor concepts, so their immunity to radiation damage under these types of conditions will need to be confirmed. Our understanding of radiolytic effects in chloride salts builds from experience in using them as reprocessing media to dissolve solid nuclear fuels and perform separations. Molten alkali chloride mixtures used for pyroprocessing exhibited good chemical and radiation stability at the radiation levels associated with processing fuel with short decay periods (3–6 months). Experiments are yet to be conducted to confirm the stability of molten chlorides under the more intense conditions of irradiation as a fuel salt. Out-of-reactor studies have also been conducted on solid fluoride and chloride salts using alpha, beta, gamma, and x-ray irradiation [48–51].

There is another dimension to irradiation damage in solid salts that has not received much attention. In the solid state, a multicomponent halide is a mixture of different crystal sizes and types. The distribution of crystal sizes and types depends on the cooling history of the melt. A solid boule of the unirradiated MSRE salt contained four major phases, as shown in Figure 10.

MSRE fuel salt
equilibrium
crystalline phases

Phase	mol%
2LiFBeF_2	77.0
2LiFZrF_4	14.3
7LiF6UF_4	2.6
BeF_2	6.1

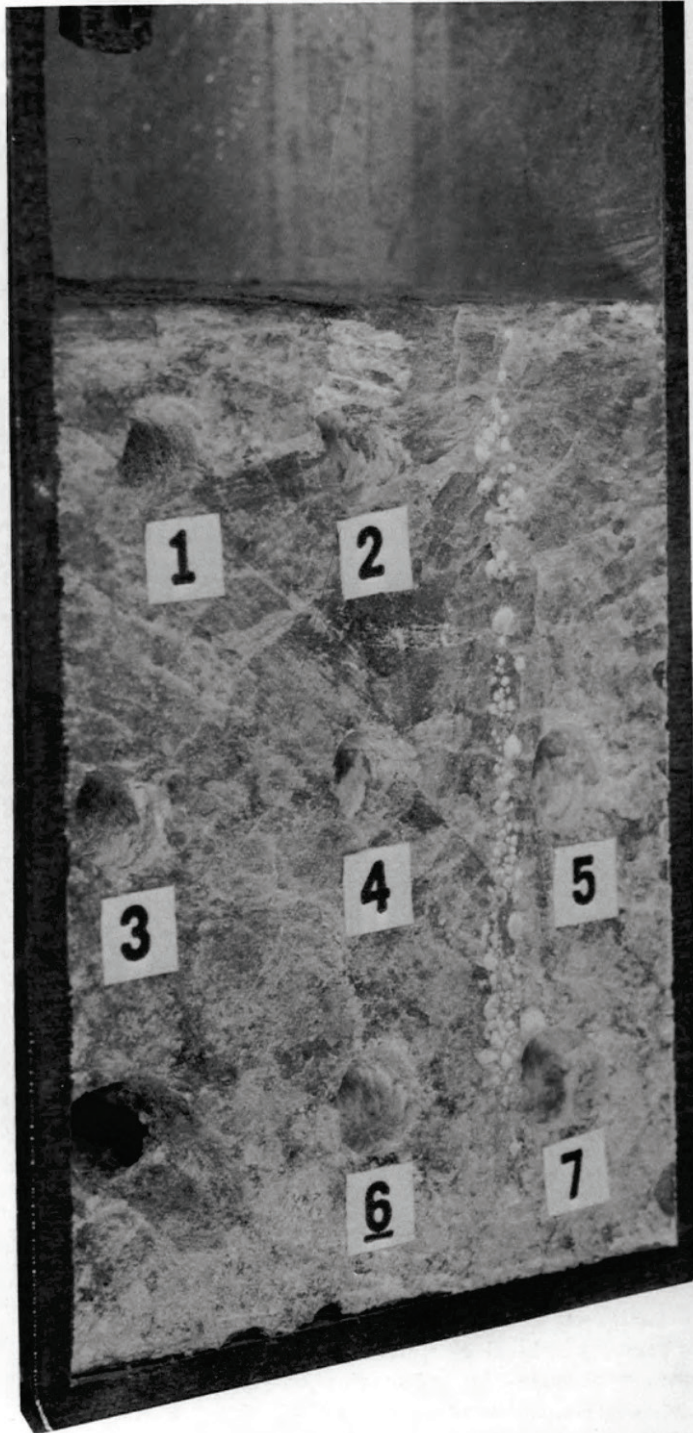
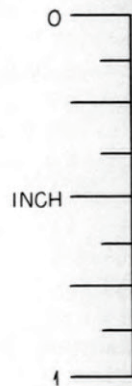

POSITION	WEIGHT % U
1	2.94
2	3.49
3	4.15
4	3.32
5	4.28
6	4.62
7	5.74

Fig. 1.5. Ingot from Slower Cooling Rate Experiments of MSRE Fuel.

Figure 10. MSRE salt phase segregation on cooling [52].

The purpose of the study [52] depicted in Figure 10 was to bound how much uranium segregation could occur during freezing. As irradiated salt is cooled to a solid, not only does the fissile component distribute according to phase equilibrium and crystallization dynamics but the fission products also distribute themselves according to their phase equilibria. For the MSRE and MSBR salts, fission-product phase distributions received some study. In general, it was found (as expected) that soluble fission products (e.g., Rb, Cs, Sr, Ba, Zr) within the same chemical/space group (e.g., IA, IIA, IVA) already present in the salt (e.g., LiF, BeF₂, ZrF₄) would be substituted into the phases of the major salt constituents. The rare earths were an exception. This class of soluble fission product was not incorporated into a phase associated with the unirradiated fuel salt.

The impact of this nonuniform distribution of fission products throughout the solid salt is that different regions (and even micro-domains) will receive different radiation exposures. Since each crystal also exhibits a distinct radiolysis behavior, taking account of this heterogeneity is important, as is accurate thermal modeling, because the radiolysis is strongly influenced by temperature. Some simplification occurs for the effect of long-energy-track radiation, such as gamma rays; but the fraction of gamma energy deposited in the salt must also be accounted for from both internal and external sources (e.g., neighboring tanks/sources).

2.4 MATERIALS COMPATIBILITY CHALLENGES

The identification of suitable core and container materials for molten salt service must take into account a number of requirements and involves a number of trade-offs. The core and container material must retain adequate strength, toughness, and creep resistance for the neutron exposure that is accumulated; endure contact with molten salt over a range of temperatures without excessive corrosion; be stable with regard to the external atmosphere surrounding the exterior of the container (and tolerate whatever atmospheric in-leakage that forms the basis for safety evaluation); and be able to be fabricated into the complex shapes of the primary loop (and sometimes the secondary loop) of the reactor. For service in the secondary loop, the material must also exhibit compatibility with a separate working fluid (e.g., steam, CO₂, helium for a power conversion system, or another high-temperature heat transfer agent), but the requirements for neutron exposure durability are almost completely absent. Although durability under neutron exposure is a very important property, it is not unique to molten salt systems. Because the corrosion phenomenon in molten salts is distinctive, it is highlighted first.

2.4.1 Corrosion

There are a number of excellent reviews of the extensive corrosion studies on fluoride salts at ORNL that led to the development of Hastelloy-N, its highly successful deployment in the MSRE, and its optimization for the MSBR program [53]. For the reader less familiar with this history, the following section summarizes some key points. There are parallels with the chemistry in chloride melts to the principles outlined below for fluorides.

Unlike the case for more conventional oxidizing media, the products of oxidation of metals by fluoride melts tend to be completely soluble in the corroding media [54]; hence, passivation is precluded, and corrosion depends directly on the thermodynamic driving force of the corrosion reactions [55]. Design of a chemically stable system using molten fluoride salts therefore

demands the selection of salt constituents that are not appreciably reduced by available structural metals and the development of containers whose components are in near thermodynamic equilibrium with the salt medium.

Examination of the free energies of formation for the various alloy components in Inconel or Hastelloy-N shows that chromium is the most active of the metal components. Therefore, any oxidizing reactions with nickel-base alloys are expected to show selective attack on the chromium constituent. Such oxidation and selective attack follow from reactions such as the following [56] for the fuel salt.

Impurities dissolved in the melt attack chromium directly producing dissolved CrF_2 :

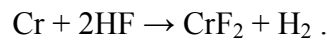
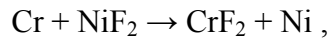

Oxide films on the metal are converted to corrosive dissolved species:

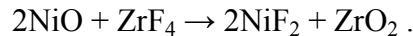

These reactions are followed by reaction of NiF_2 with Cr cited above, and reduction of excess UF_4 to UF_3 :

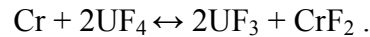

Of course, in the case of a coolant salt with no fuel component, this reaction with uranium would not be a factor.

The phenomenon described above falls into the class of “temperature-gradient mass transfer” that occurs without a protective film of any sort and has some features in common with liquid metal corrosion. When dissimilar materials contain molten salt, an activity gradient corrosion can occur in the absence of any temperature-gradient driving force (or it can act in combination with a thermal gradient). The generalized concept of temperature-gradient mass transfer is depicted in Figure 11.

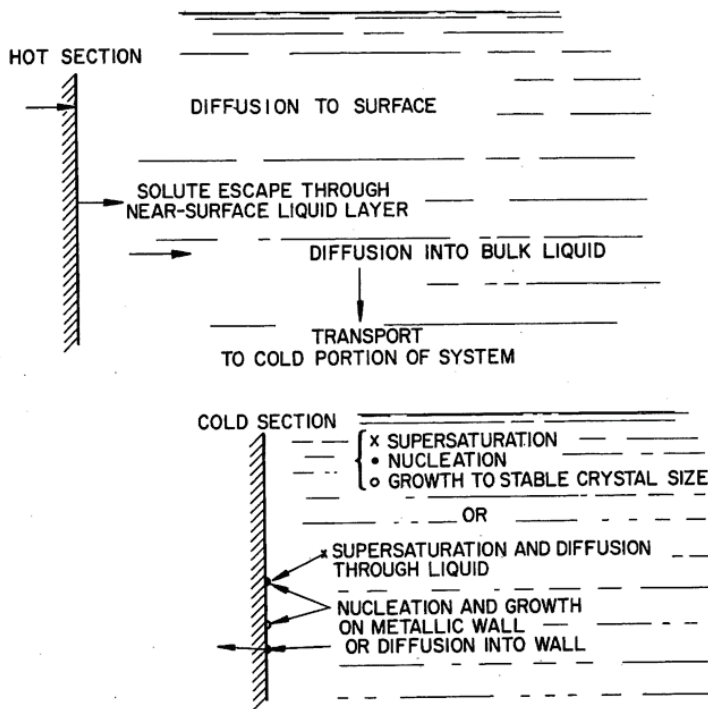

Figure 11. Temperature-gradient mass transfer [53].

It was the thermally driven UF_4/UF_3 redox couple that was believed to be the primary source of persistent corrosion in the fuel salt loop after impurity-driven corrosion had been played out, and is depicted in Figure 12.

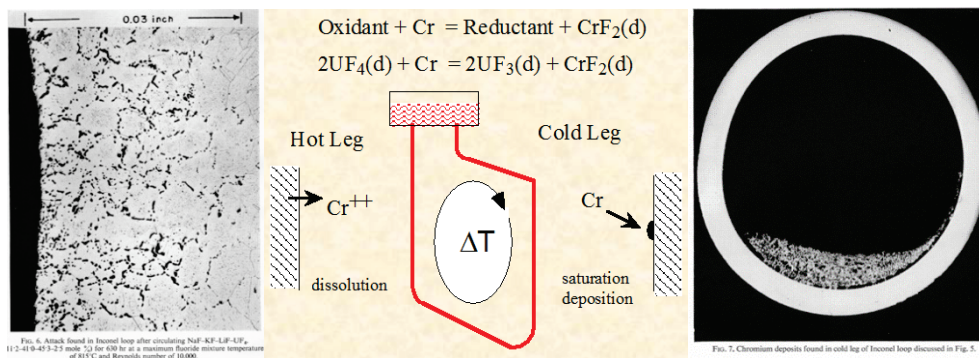

Figure 12. Persistent salt corrosion as a temperature-gradient-driven redox cycle [54].

Redox processes that are responsible for attack by molten fluoride mixtures on high-temperature alloys result in selective oxidation of the least noble metal—typically chromium. Removal of chromium from the alloy occurs primarily in the regions of the highest temperature and results in the formation of discrete voids in the alloy [57]. These voids are not, in general, confined to the grain boundaries in the metal but are relatively uniformly distributed throughout the alloy surface that is in contact with the melt. The rate of corrosion has been measured and was found to be controlled by the rate at which chromium diffuses to the surfaces undergoing attack [58].

With regard to our current understanding of the corrosion process, there are some important gaps. The following questions can be posed:

- In the absence of a redox-sensitive soluble species (as was largely the case for the MSRE 2LiF-BeF₂ coolant), what is the mechanism of corrosion in a polythermal loop?
- Is it better to have a substantial redox buffer (which will have some redox-temperature coefficient) in a coolant salt and drive it to a reducing condition, or is it better to have no (or very low levels of) redox-sensitive species in solution and maintain it in a reducing state by other means?
- If a redox-sensitive species is a major constituent of the salt (as is the case for a uranium-containing fuel salt), is it more advantageous to have high concentrations and maintain the salt in a very reducing condition (and thus have a very large buffer capacity), or is it better to have a lower concentration of redox-sensitive species?
 - Work in the 1950s during the ANP program indicated that higher uranium concentrations in the salt accelerated the persistent polythermal corrosion mechanism.
- What is the effect of different salt compositions on polythermal redox-driven corrosion?
 - Work in the late 1950s and 1960s indicated that very basic¹ uranium fuel salts (e.g., low concentrations of UF₄ dissolved in FLiNaK, a.k.a. “Fuelinak”) had much larger thermal coefficients of corrosion than other uranium-containing salts that had fewer uncomplexed fluoride anions (e.g., neutral 2LiF-BeF₂ or acidic NaF-ZrF₄ salts).
 - The very high uranium- and plutonium-content salts proposed for some new MSR concepts are significantly different from those tested in the past.
- Are iron-based alloys an option for halide salts if the salt is maintained under very reducing conditions [59]? What are the salt redox window and compositional window for iron-based alloys? What is the response of iron alloys to design-basis corrosive inputs compared with nickel-based alloys?

2.4.2 Irradiation (Neutron) Damage Limits

The irradiation damage limits associated with the use of conventional nickel superalloys and stainless and ferritic/martensitic steels have been studied extensively [60–62], although incremental improvements in alloy performance and our understanding of it continue [63].

These conventional materials do not exhibit the long lifetimes typically desired for nuclear components; this is an especially dramatic shortfall for fast-reactor applications. However, the thermal neutron effects remain an important constraint limiting higher temperatures and exposures for nickel-based superalloys. Figure 13 depicts the dual materials challenges posed for MSR systems as higher temperatures and atomic displacements are sought.

¹ Basic in the sense of the Lewis acid-base theory—possessing an abundance of electron donors (uncomplexed fluoride anions in salts that are predominantly alkali halides such as FLiNaK).

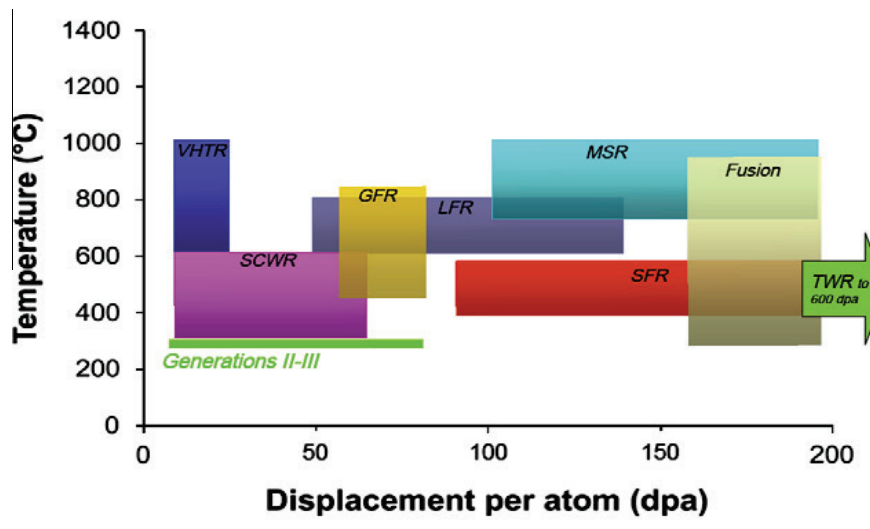

Figure 13. Dual challenges of higher temperatures and displacements for MSR in-core structural materials [61].

The situation is not as challenging for container alloys or primary loop components outside the core because they see considerably less intense radiation fields, but existing materials were still seen as having some shortfalls at the end of the MSBR program. Whether these shorter material lifetimes are suitable is an economic decision and depends on the particular system design.

3. TECHNOLOGY AND APPLIED R&D NEEDS

In the most general terms, the technology and applied R&D needs highlighted in the previous sections can be summarized as follows:

1. Create a systematic computational approach to salt selection that balances and encompasses all neutronic and chemical factors.
2. Predict phase diagrams, solubilities, vapor pressures, and all relevant thermophysical and transport properties.
3. Develop rugged and reliable in-line chemical and isotopic sensors in conjunction with the development of out-of-pile and in-pile test stands.
4. Create a spatially and temporally accurate predictive model of fission/activation product production coupled with the ability to accurately track the fate and transport of this activity.
5. Develop a discriminating model of corrosion and materials compatibility for a variety of salt redox conditions and salt compositions that permits the most favorable operating envelope to be identified and the most appropriate salts and materials (or groups of materials) to be discovered, developed, and designed.
6. Discover new materials and ways to use existing materials that can extend the high-temperature and neutron flux/fluence boundaries that currently exist.
7. Conceive and formulate a fine-grained predictive understanding of radiolytic processes in solid salts to permit in-pile testing, interim salt storage, and disposition of salt-based wastes.

4. REFERENCES

1. W. R. Grimes and D. R. Cuneo, "Molten salts as reactor fuels," in *Reactor Handbook* vol.1 (Materials), ed. C. R. Tipton Jr., Interscience Publishers, New York, 1960, 2nd Edition, p. 425.
2. W. R. Grimes et al., "Chemical aspects of molten fluoride salt reactor fuels," in *Fluid-Fueled Reactors*, ed. J. A. Lane et al., Addison-Wesley, New York, 1958, chap. 12.
http://moltensalt.org/references/static/downloads/pdf/FFR_chap12.pdf
3. W. R. Grimes, *Chemical Research and Development for the Molten-Salt Breeder Reactor*, ORNL/TM-1853, Oak Ridge National Laboratory, 1967.
<http://web.ornl.gov/info/reports/1967/3445605995384.pdf>
4. W. R. Grimes, "Molten Salt Reactor Chemistry," *Nuclear Applications and Technology* 8(2), 137–155 (1970). http://moltensalt.org/references/static/downloads/pdf/NAT_MSRchemistry.pdf
5. D. F. Williams and K. T. Clarno, "Evaluation of salt coolants for reactor applications," *Nuclear Technology* 163(3), 330–343 (2008). http://www.ans.org/pubs/journals/nt/a_3992
6. Y. Hirose, and Y. Takashima, "The concept of fuel cycle integrated molten salt reactor for transmuting Pu+MA from spent LWR fuels," paper FP163 at the GLOBAL 2001 Conference, Paris France (2001).
http://www.iaea.org/inis/collection/NCLCollectionStore/_Public/33/034/33034365.pdf?r=1
7. J. R. Keiser, *Status of Tellurium-Hastelloy N Studies in Molten Fluoride Salts*, ORNL-TM-6002, Oak Ridge National Laboratory, October 1977. <https://www.osti.gov/scitech/servlets/purl/7295251>
8. V. V. Ignatiev et al., "Experimental investigation of tellurium corrosion of nickel-molybdenum alloys in molten lithium-beryllium- and uranium-fluoride salts," *Atomic Energy* 120(6), 2016.
<https://link.springer.com/article/10.1007/s10512-016-0148-1>
9. W. R. Grimes, "Molten fluoride mixtures as possible fission reactor-fuels," *Journal of the Electrochemical Society* 125(3), C161 (1978). <https://www.osti.gov/scitech/servlets/purl/6741721>
10. B. R. Harder et al., "Compatibility and processing problems in the use of molten uranium chloride—Alkali chloride mixtures as reactor fuels," in *Nuclear Metallurgy 15*, P. Chiotti, ed. (1969).
<https://www.osti.gov/scitech/biblio/4747246>
11. R. E. Thoma et al., "Equilibrium phase diagram of lithium fluoride-beryllium fluoride-zirconium fluoride system," *Journal of Nuclear Materials* 27(2), 166 (1968).
12. D. F. Williams, *Assessment of Candidate Molten Salt Coolants for the Advanced High Temperature Reactor (AHTR)*, ORNL/TM-2006/12, Oak Ridge National Laboratory, 2006.
<http://info.ornl.gov/sites/publications/Files/Pub57476.pdf>
13. E. Capelli, O. Benes, and R. J. M Konings, "Thermodynamic assessment of the LiF–ThF₄–PuF₃–UF₄ system," *Journal of Nuclear Materials* 462, 43–53 (2015).
14. G. J. O. Beran, "Modeling polymorphic molecular crystals with electronic structure theory," *Chemical Reviews* 116, 5567–5613 (2016).
15. S. Hirata et al., "Ab initio molecular crystal structures, spectra, and phase diagrams," *Acc. Chem. Res.* 47, 2721–2730 (2014).
16. D. Corradini et al., "Coordination numbers and physical properties in molten salts and their mixtures," *Faraday Discuss.* 190, 471 (2016).
17. Y. Ishii et al., "Thermal conductivity of molten alkali metal fluorides (LiF, NaF, KF) and their mixtures," *The Journal of Physical Chemistry B* 118, 3385–3391 (2014).

18. A. E. Gheribi et al., "Prediction of the thermophysical properties of molten salt fast reactor fuel from first-principles," *Molecular Physics* 112, 1306–1312 (2014).
19. F. Lantelme and H. Groult, *Molten Salts Chemistry: From Lab to Applications* (2013).
20. P. A. Madden and M. Salanne, "Thorium molten salts: Theory and practice," *Thorium Energy for the World*, pp. 111–116 (2016). http://link.springer.com/chapter/10.1007/978-3-319-26542-1_15
21. L. C. Dewan et al., "Molecular dynamics simulation of the thermodynamic and transport properties of the molten salt fast reactor fuel LiF–ThF₄," *Journal of Nuclear Materials* 434 322–327 (2013).
22. M. W. Rosenthal, *The Development Status of Molten-Salt Breeder Reactors*, ORNL-4812, Oak Ridge National Laboratory, August 1972. <http://web.ornl.gov/info/reports/1972/3445604501750.pdf>
23. H. A. Laitinen, "History of electroanalytical chemistry in molten-salts," *ACS Symposium Series* 390, 417–428 (1989).
24. D. K. Corrigan et al., "Advances in electroanalysis, sensing and monitoring in molten salts," *Faraday Discuss.* 190, 351–366 (2016).
25. M. M. Tylka et al., "Method development for quantitative analysis of actinides in molten salt," *Journal of the Electrochemical Society* 162(9), H625–633 (2015).
26. B. Kelleher et al., "Observed redox potential range of Li₂BeF₄ using a dynamic reference electrode," *Nuclear Technology* 195, 239 (2016).
27. G. Duran-Klie et al., "Dynamic reference electrode development for redox potential measurements in fluoride molten salt at high temperature," *Electrochimica Acta* 195, 19–26 (2016).
28. J. Zhang, "Electrochemistry of actinides and fission products in molten salts—Data review," *Journal of Nuclear Materials* 447, 271–284 (2014).
29. K. Song et al., "Spectroscopic studies of lanthanides ion in high-temperature molten salt," *Applied Spectroscopy Reviews* 50(8), 654–669 (2015).
30. E. L. Compere et al., *Fission Product Behavior in the MSRE*, ORNL-4865, Oak Ridge National Laboratory, 1975. <http://web.ornl.gov/info/reports/1975/3445605698493.pdf>
31. R. J. Kedl, *The Migration of a Class of Fission Products in the MSRE*, ORNL/TM-3884, Oak Ridge National Laboratory, 1973. <https://www.osti.gov/scitech/biblio/4471292-migration-class-fission-products-noble-metals-molten-salt-reactor-experiment>
32. R. B. Briggs, "Tritium in molten salt reactors," *Reactor Technology* 14(4), 335 (1972).
33. R. B. Briggs, "Tritium in molten salt reactors—Reply," *Reactor Technology* 15(1), 79 (1972).
34. R. B. Briggs, *Calculation of the Tritium Distribution in the MSRE*, CF-70-7-13, Oak Ridge National Laboratory, 1970, and *Additional Calculations of the Distribution of Tritium in the MSRE*, ORNL/CF 71-7-8, Oak Ridge National Laboratory, 1971.
35. G. T. Mays, *Distribution and Behavior of Tritium in the Coolant-Salt Technology Facility*, ORNL/TM-5759, Oak Ridge National Laboratory, 1977. <http://moltensalt.org/references/static/downloads/pdf/ORNL-TM-5759.pdf>
36. L. Maya, "Identification of polyborate and fluoropolyborate ions in solution by Raman spectroscopy," *Inorganic Chemistry* 15(9), 2180 (1976).
37. R. B. Briggs and C. W. Nestor, *A Method for Calculating the Steady-State Distribution of Tritium in a Molten-Salt Breeder Reactor Plant*, ORNL/TM-4804 Oak Ridge National Laboratory, 1975. <http://web.ornl.gov/info/reports/1975/3445605505619.pdf>

38. J. D. Stempien et al., “An integrated model of tritium transport and corrosion in fluoride salt-cooled high-temperature reactors (FHRs)—Part I: Theory and benchmarking,” *Nuclear Engineering and Design* 310, 258–272 (2016).
39. D. Zhang, “Permeation of hydrogen in Hastelloy C-276 at high temperature,” *Fusion Science and Technology* 67, 681 (2015).
40. E. Ianovici and M. Taube, *Chemical State of Sulphur Obtained by the $^{35}\text{Cl} (n, p) ^{35}\text{S}$ Reaction during in-pile Irradiation*, Swiss Institute for Reactor Technology (Wurenlingen) Report, EIR-267 (1974).
<http://moltensalt.org/references/static/downloads/pdf/EIR-267.pdf>
41. M. Taube and J. Ligou, “Molten plutonium chlorides fast breeder reactor cooled by molten uranium chloride,” *Annals of Nuclear Science and Engineering* 1, 277 (1974).
42. E. Ianovici and M. Taube, “Chemical behavior of radiosulphur obtained by $^{35}\text{Cl} (n, p) ^{35}\text{S}$ during in-pile irradiation,” *Journal of Inorganic and Nuclear Chemistry* 37, 2562 (1977).
43. M. Furrer, “Chemical behaviour of radiosulphur obtained by $^{35}\text{Cl} (n, p) ^{35}\text{S}$ during in-core irradiation of alkali-chloride melts,” *Journal of Inorganic and Nuclear Chemistry* 39, 1086 (1977).
44. M. Taube, *Fast Reactors Using Molten Chloride Salts as Fuel: Final Report (1972–1977)*, Swiss Institute for Reactor Technology (Wurenlingen) Report, EIR-332 (1978).
http://www.iaea.org/inis/collection/NCLCollectionStore/_Public/13/648/13648304.pdf
45. D. F. Williams et al., *A Descriptive Model of the MSRE after Shutdown: Review of FY 1995 Progress*, ORNL/TM-13142, Oak Ridge National Laboratory, 1996.
<https://www.osti.gov/scitech/servlets/purl/230260>
46. D. F. Williams, A. S. Icenhour, L. D. Trowbridge, G. D. Del Cul, L. M. Toth, “Radiolysis studies in support of the remediation of the Molten Salt Reactor Experiment,” *Transactions of the American Nuclear Society* 81, 89–90 (1999).
47. W. R. Grimes, *Radiation Chemistry of MSR System*, ORNL/TM-500, Oak Ridge National Laboratory, 1963. <http://web.ornl.gov/info/reports/1963/3445605493999.pdf>
48. L. M. Toth and L. K. Felker, “Fluorine generation by gamma radiolysis of a fluoride salt mixture,” *Radiat. Eff. Def. Solids* 112, 201–210 (1990).
49. A. B. Lidiard, “The radiolysis of alkali halides—The nucleation and growth of aggregates,” *Zeitschrift fur Physikalische Chemie* 206, 219–248 (1998).
50. L. Tandon, *Radiolysis of Salts and Long-Term Storage: Issues for Both Pure and Impure PuO_2 Materials in Plutonium Storage Containers*, LA-13725-MS, Los Alamos National Laboratory, 2000.
http://www.iaea.org/inis/collection/NCLCollectionStore/_Public/32/016/32016719.pdf
51. D. K. Veirs et al., *Evidence of Corrosive Gas Formed by Radiolysis of Chloride Salts in Plutonium-Bearing Materials*, SRNL-STI-2010-00051, Savannah River National Laboratory, 2010.
<http://sti.srs.gov/fulltext/SRNL-STI-2010-00051.pdf>
52. H. A. Friedman and R. E. Thoma, “MSRE fuel fractionation experiments,” in *Reactor Chemistry Division Annual Progress Report for Period Ending January 31, 1965*, W. R. Grimes et al., eds., ORNL-3789, Oak Ridge National Laboratory, April 1965.
<http://web.ornl.gov/info/reports/1965/3445605716008.pdf>
53. J. W. Koger, “Chromium depletion and void formation in Fe-Ni-Cr alloys during molten salt corrosion and related processes,” in *Advances in Corrosion Science and Technology*, vol. 4, M. G. Fontana and R. W. Staehle, eds. (1974).

54. W. D. Manly et al., "Metallurgical problems in molten fluoride systems," *Progress in Nuclear Energy*, Series IV 2, 164–179 (1960).
55. J. H. DeVan and R. B. Evans III, *Corrosion Behavior of Reactor Materials in Fluoride Salt Mixtures*, ORNL/TM-328, Oak Ridge National Laboratory, September 1962. <http://web.ornl.gov/info/reports/1962/3445605700621.pdf>
56. W. R. Grimes, *Chemical Research and Development for the Molten-Salt Breeder Reactor*, ORNL/TM-1853, Oak Ridge National Laboratory, 1967. <http://web.ornl.gov/info/reports/1967/3445605995384.pdf>
57. L. S. Richardson, D. E. Vreeland, and W. D. Manly, *Corrosion by Molten Fluorides*, ORNL-1491, Oak Ridge National Laboratory, March 1953. <http://web.ornl.gov/info/reports/1953/3445603532247.pdf> see also <http://web.ornl.gov/info/reports/1969/3445605136769.pdf>
58. J. H. Devan, *Effect of Alloying Additions on Corrosion Behavior of Nickel-Molybdenum Alloys in Fused Fluoride Mixtures*, University of Tennessee Thesis, August 1960, see also ORNL/TM-2021, Oak Ridge National Laboratory, 1969. <https://www.osti.gov/scitech/servlets/purl/4789147>
59. J. R. Keiser et al., *The Corrosion of Type 316 Stainless Steel to Li_2BeF_4* , ORNL/TM-5782, Oak Ridge National Laboratory, April 1977. <https://www.osti.gov/scitech/servlets/purl/4789147>
60. H. E. McCoy, *Status of Materials Development for Molten Salt Reactors*, ORNL/TM-5920, Oak Ridge National Laboratory, January 1978. <https://www.osti.gov/scitech/servlets/purl/5195742>
61. S. J. Zinkle and G. S. Was, "Materials challenges in nuclear energy," *Acta Materialia* 61 (2013) 735–758.
62. S. J. Zinkle, K. A. Terrani, and L. L. Snead, "Motivation for utilizing new high-performance advanced materials in nuclear energy systems," *Current Opinion in Solid State and Materials Science* 20, 401–410 (2016).
63. L. Jiang et al., "M₂C and M₆C carbide precipitation in Ni-Mo-Cr based superalloys containing silicon," *Materials and Design* 112, 300–308 (2016).

APPENDICES

- A. Molten Salt Reactor Technical Working Group Descriptions of Reactor Systems under Consideration
- B. 1969 Molten Salt Reactor Experiment Video
- C. Molten Salt Reactor Excerpts from “An Account of ORNL’s 13 Research Reactors” by Murray Rosenthal

**APPENDIX A.
THUMBNAIL SUMMARIES OF REACTOR CONCEPTS
UNDER CONSIDERATION BY MSR
TECHNICAL WORKING GROUP**

<p>Elysium Molten Salt Reactor Concept</p> <ul style="list-style-type: none"> • Rated electric output 1,000 MW_e • Chloride fuel salt • Fast spectrum neutron flux • Core outlet temperature of >600°C • Core inlet temperature of ~500°C • Employs drain valve <p>www.elysiumindustries.com/</p>	<p>FLiBe Energy</p> <ul style="list-style-type: none"> • Liquid Fluoride Thorium Reactor (LFTR) – Thorium fuel cycle • Graphite moderated, thermal spectrum, LiF-BeF₂-UF₄ fuel • Freeze valve and drain tank based decay heat rejection • Described in EPRI technical report – 3002005460, October 2015 <p>— https://www.epri.com/#/pages/product/000000003002005460/</p> <p>— https://aris.iaea.org/PDF/LFTR.pdf</p> <p>http://flibe-energy.com/</p>
<p>Kairos Power</p> <ul style="list-style-type: none"> • Solid-fueled fluoride-salt-cooled concept with demonstration targeted by 2030 • Uses ceramic TRISO coated fuel particles in a pebble fuel element design. • Proposes nuclear air combined cycle for flexible, responsive power generation <ul style="list-style-type: none"> — co-fired with natural gas or hydrogen for peaking power • PB-FHR described at https://aris.iaea.org/PDF/Mk1%20PB-FHR%20ARIS%20final.pdf <p>http://kairopower.com/</p>	<p>Moltex Energy</p> <ul style="list-style-type: none"> • UK company – Stable Salt Reactor (SSR) concept • NaCl-(Actinide)Cl₃ fuel salt (LEU, <15% ²³⁵U) <ul style="list-style-type: none"> — Redox stabilized with Zr/ZrCl couple • NaF-ZrF₄ coolant salt <ul style="list-style-type: none"> — ZrF₂/ZrF₄ redox buffer • Natural circulation of fuel salt within vented fuel pins • Steel cladding similar to that used in Dounreay SFR <p>https://aris.iaea.org/PDF/SSR.pdf</p> <p>http://www.moltexenergy.com/</p>

Fig. A-1. Thumbnail descriptions of Molten Salt Reactor Technical Working Group reactor concepts.

<p>TerraPower</p> <ul style="list-style-type: none"> • Molten Chloride Fast Reactor (MCFR) uses chloride-based fuel salt • Employs reflector <ul style="list-style-type: none"> — Reduce dose to containment — Improve neutron economy — Reduce radiation level within shielding — Integral heat exchangers • Integral heat exchangers <p>http://terrapower.com/news/terrapowers-continuing-innovation</p>	<p>Terrestrial Energy USA</p> <ul style="list-style-type: none"> • Integral Molten Salt Reactor concept <ul style="list-style-type: none"> — Denatured U/Pu fuel cycle and LEU fluoride salt fuel containing constituents such as LiF, NaF, BeF₂. — Graphite moderator — Sealed primary unit with integrated pumps, heat exchangers, and shutdown rods • Seven year reactor vessel, moderator, and fuel salt lifetime <ul style="list-style-type: none"> — Twin reactor module configuration – one module swapped every seven years <p>https://aris.iaea.org/PDF/IMSR400.pdf https://aris.iaea.org/Publications/SMR-Book_2016.pdf</p>
<p>Thorcon Power</p> <ul style="list-style-type: none"> • Fuel salt comprised of NaF and BeF₂ with 12mol% actinide <ul style="list-style-type: none"> — 80% of actinide is thorium, 20% uranium (~20% ²³⁵U) • Fuel salt and moderator replaced every four years in twin reactor modular configuration <p>https://aris.iaea.org/PDF/ARISThorCon9.pdf http://thorconpower.com/</p>	<p>Transatomic</p> <ul style="list-style-type: none"> • 5% enrichment LEU fuel salt, such as LiF-UF₄ eutectic • Zirconium hydride in movable rods <p>http://www.transatomicpower.com/wp-content/uploads/2015/04/TAP-White-Paper-v2.1.pdf http://www.transatomicpower.com/</p>

Fig. A-2. Thumbnail descriptions of Molten Salt Reactor Technical Working Group reactor concepts (continued)

**APPENDIX B.
1969 MOLTEN SALT REACTOR
EXPERIMENT VIDEO**

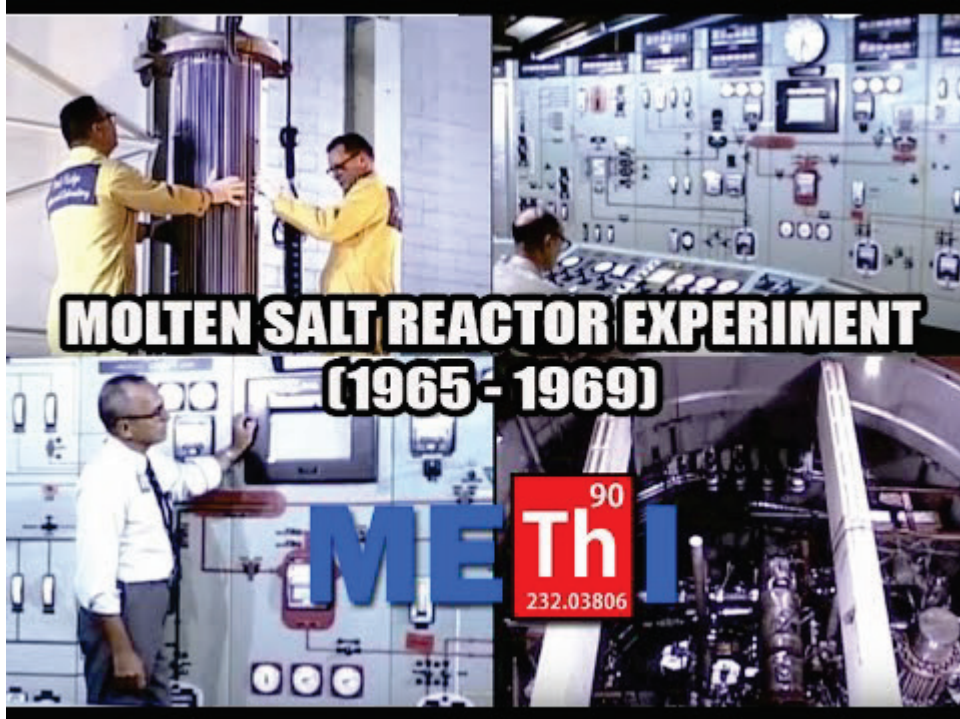

Oak Ridge National Laboratory. 1969. "The Molten Salt Reactor Experiment." Video. Available: <https://www.youtube.com/watch?v=tyDbq5HRs0o>.

**APPENDIX C. MOLTEN SALT REACTOR EXCERPTS FROM “AN
ACCOUNT OF ORNL’S 13 RESEARCH REACTORS” BY
MURRAY ROSENTHAL**

(Complete document at <http://info.ornl.gov/sites/publications/files/Pub20808.pdf>)

AIRCRAFT NUCLEAR PROPULSION PROGRAM

In 1946, the Air Force initiated a program to develop a nuclear-powered airplane and contracted with the Fairchild Engine and Airplane Corporation to evaluate its feasibility. Fairchild set up a project in an unused building near the K-25 gaseous diffusion plant (now the East Tennessee Technology Park) in Oak Ridge, Tennessee. Oak Ridge National Laboratory (ORNL) provided assistance.

There was considerable skepticism, and before getting more deeply involved, the Atomic Energy Commission (AEC) asked staff at the Massachusetts Institute of Technology to perform an independent evaluation. A summer project at Lexington, Massachusetts, concluded after initial doubts that developing nuclear-powered aircraft would cost as much as \$1 billion and take 15 y but was feasible.

So under Cold War pressure, the AEC directed ORNL to establish the Aircraft Nuclear Propulsion (ANP) Program. It grew to be the Laboratory's largest activity for a number of years. General Electric (GE) eventually replaced Fairchild and moved its program to Evendale, Ohio. But about 180 people remained in Oak Ridge and joined ORNL's program, which by 1951 filled a big building at the Oak Ridge Y-12 Plant (now the Y-12 National Security Complex).

Two approaches to nuclear propulsion were considered. In the direct cycle, air for the jet engine would pass through the reactor and be directly heated to 1,700°F. In the indirect cycle, a molten metal would flow through a reactor and then through a heat exchanger where it would heat the air. GE undertook to develop the direct cycle and ORNL undertook development of the indirect cycle.

Aircraft Reactor Experiment Development

ORNL proposed building a small reactor to guide its development program. Funded by the AEC, this reactor was called the Aircraft Reactor Experiment (ARE). To permit high temperature, BeO was chosen as the moderator. The core was to be a stack of hexagonal blocks with vertical passages for the fuel elements and molten sodium coolant. Because of the time needed for production of the BeO blocks, they were ordered before the design was completed. The blocks stacked up to form the core are shown in Figure C-1. The fuel elements themselves were to be long, thin stainless-steel tubes containing UO₂. Details are given in Table C-1.

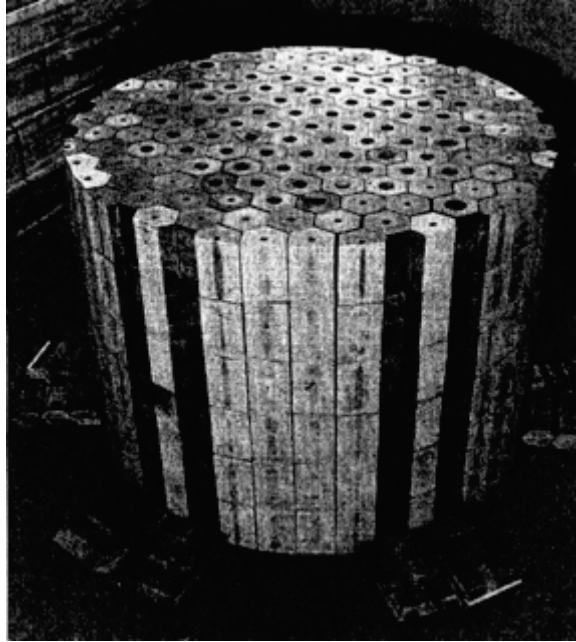

Figure C-1. Stacked BeO moderator blocks for the ARE.

An extensive research and development program was undertaken in chemistry, materials, high-temperature sensors, and other areas, and components such as pumps and valves were tested in loops. Protecting the aircraft's crew and components and the public from radiation was critical. Consequently, ORNL launched a broad program on the penetration of gamma rays and neutrons, including measurements of the shielding properties of a variety of materials and the development of calculation methods. That led to reactors built just for shielding studies, about which more will be said later.

As the ARE design progressed, however, two serious questions arose. One came from physics calculations that showed that the cross section of xenon-135 at elevated temperatures could cause a positive temperature coefficient in a high-power solid-fuel reactor. The other was doubts about the reliability of "spaghetti-like" fuel elements operating at the temperatures that would be necessary.

An alternate idea arose in which a uranium compound would be dissolved in a molten salt and solid fuel elements avoided. The salt would flow through the core, where it would be heated by fissions, and then pass through a heat exchanger. The xenon gas was expected to evolve from the salt and be removed, but even if it did not, much of it would be outside the core in the external system. So the fuel rods were replaced by a molten salt.

After considering other salts, the choice of carrier salt was a "relatively" low melting temperature (950°F) mixture of sodium and zirconium fluorides into which UF_4 was dissolved. The fluoride salts when solid look somewhat like green table salt, but as seen in Fig. C-2, when molten they resemble water. Alkali fluorides are among the most stable of compounds, which means they do not corrode stainless steels and similar alloys. They also have very low vapor pressures, and when molten, they are not damaged by radiation.



Figure C-2. ORNL photograph of molten salt, featured on the cover of the British *Science Journal* in June 1969. Used by permission; (*Science Journal* was incorporated into *New Scientist*, www.newscientist.com, in 1971).

The salt would flow through the core in the passages that were designed to hold the solid elements, but in a single pass the velocity would have been too low for turbulent flow. This was dealt with by having the fuel make multiple passes at higher velocity. The core with the multiple-pass tubes is seen in Figure C-3. The salt emerging from the core was pumped through a finned-tube heat exchanger, where it was cooled by helium, which was in turn cooled by water, as shown schematically in Figure C-4.

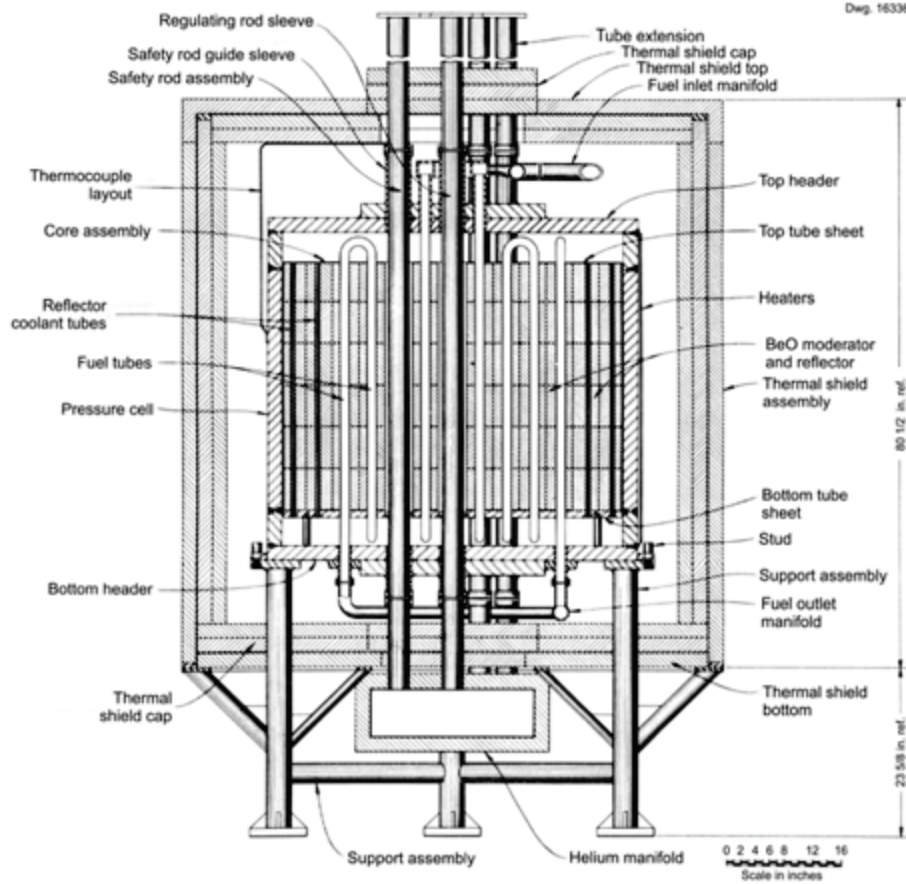

Figure C-3. Elevation view of the ARE core. (ORNL Drawing 16336).

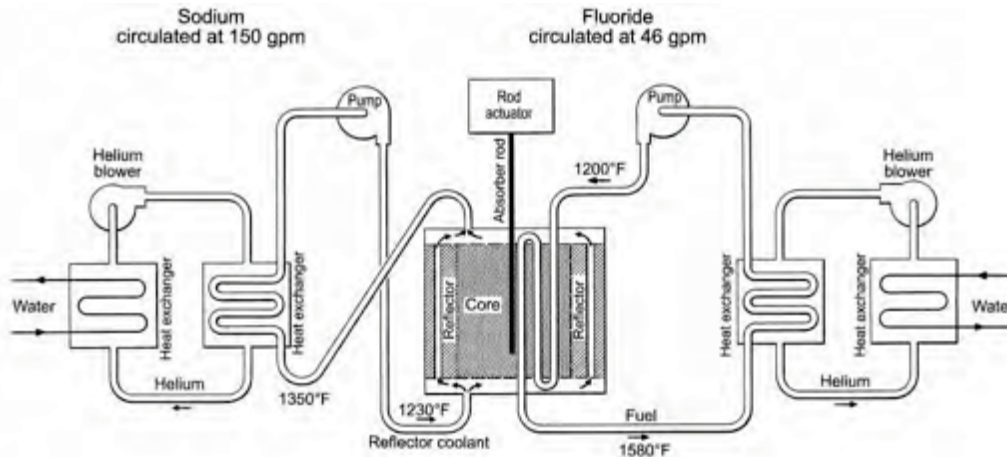

Figure C-4. ARE flow diagram.

Heat generated in the moderator and reflector was removed in a sodium system that was similar to the salt system. For safety, the sodium system had two independent circuits, and the fuel salt system contained a standby pump and heat exchanger to ensure continued operation. Sump-type centrifugal pumps with overhung impellers were used, and the sumps served as expansion tanks.

The reactor was designed to operate with the fuel salt at around 1500°F and at a power of 1 to 3 MW of heat.

Table C-1. ARE parameters

Power (heat)	2.5 MW
Fuel salt	53% NaF, 41% ZrF ₄ , 6% UF ₄ (93% enriched)
Fuel melting point	990°F
Fuel inlet temperature	1225°F
Fuel outlet temperature	1580°F (1620° at peak)
Fuel flow rate	45 gal/min
Moderator	BeO hexagonal blocks, 3.6 in. across × 6 in. high with 1.25 in. coolant passages
Coolant	Helium to water
Container	Inconel
Critical	November 3, 1954
Shut down	November 12, 1954

The salt and sodium pipes and all major components had double walls to provide a space in which helium was circulated to maintain even temperatures and to provide leak monitoring. Control and safety rods in the core and fission chambers in the reflector were also cooled by the circulating helium.

Electrical heaters around the core and the piping raised the temperature before molten salt was added. All salt and sodium-containing systems were made from Inconel, a high-temperature nickel- base alloy.

A mill-type building was constructed in Melton Valley near the homogeneous reactors to house the ARE. All of the reactor systems were located below grade in concrete-lined pits.

ARE Operation

Operation of the ARE began in early November 1954. First the system was heated with the electrical heaters. Then it was filled with uranium-free carrier salt. And finally, fuel salt as 2NaF·UF₄ was added in increments from a heated pot that emptied into the pump bowl.

The fuel concentrate had a higher melting temperature than the carrier salt and tended to freeze in the fuel addition system. Heating the transfer line and getting the fuel concentrate to flow was the biggest operating problem of the reactor, and much of three days was spent in clearing plugs.

Overheating of the line with a welding torch caused a small hole which, however, did not prevent the loading from being completed.

Physics experiments were run at low power for several days, and then the power was raised in steps to full power over 30 hours. The ARE ran very smoothly. However, small amounts of radioactive gas leaked into the reactor compartment from the hole in the loading line and set off

alarms. That was handled by hooking up a construction compressor that exhausted air from the compartment and blew it into an uninhabited area about 1000 ft away.

The temperature coefficient of reactivity was negative as expected, and the power level could be raised or lowered by changing the speed of the blower that cooled the heat exchanger. The total power extracted in the fuel salt and sodium reached 2.5 MW with a steady-state fuel temperature of 1580°F, but the temperature exceeded 1620°F in transients. At steady conditions, the temperature rise across the core was 355°F.

The last experiment conducted was a measurement of xenon retention during a 25-hour run at full power. It indicated that no xenon remained in the salt. After all scheduled tests were completed, the reactor was cycled between full and low power 21 times within 12 hours. The operating plan was to run the ARE for 100 hours; however, when that target was reached, only 9 days of operation had been at power. Running longer was considered, but the experiment was shut down on schedule because of concern about weakness in the overheated fill line. That turned out to be a wise decision, because the line opened completely 5 days later and released radioactive gas into the reactor compartment.

The Air Force was pleased with the performance of the ARE and brought Pratt and Whitney Aircraft Company aboard to develop the indirect cycle power plant. ORNL began the design of a compact 60 MW reactor. And in spite of growing skepticism about success and the recognition that missiles might substitute for bombers, industrial and political support kept the national program going. But it was killed in March 1961 soon after John Kennedy took office.

Thus ORNL's ANP program came to an end, but in its 12-year run, it greatly expanded knowledge of the chemistry and technology of molten salts and made advances in materials, shield design, and other areas that enlarged the Laboratory's ability to undertake new projects.

MOLTEN-SALT REACTOR EXPERIMENT

With the ARE having shown the feasibility of molten-salt fuel, ORNL persuaded the AEC to fund a study of molten-salt power reactors. Two concepts were evaluated, both graphite moderated and based on the U-233/thorium fuel cycle. In one, the uranium and thorium were in the same salt. In the other, a thorium salt that formed a fertile blanket was kept separate from the fuel salt by a graphite barrier. The single-fluid concept was simpler, but a net breeding gain appeared to be possible in a two-fluid reactor.

The results of the study were encouraging. However, the AEC was still funding the homogeneous reactor program as well as a liquid-bismuth reactor program at Brookhaven National Laboratory, and it had more fluid-fuel reactors than it wanted. So a task force was created to evaluate all three programs. It concluded that the molten-salt reactor "had the highest probability of achieving technical feasibility." This led to approval of a program at ORNL to develop molten-salt power reactors and to the demise of Brookhaven's program and, as mentioned earlier, the homogeneous reactor program.

The molten-salt development program proceeded well, and by the end of 1959, the Laboratory felt justified in proposing a small reactor to investigate the technologies needed for civilian power. To keep the reactor simple and inexpensive, it had a single region like a converter, but the

salt did not contain thorium and in that sense was similar to the core of a breeder. (Later a concept was developed in which a virtual two-region reactor was created with a single salt by reducing the moderation in the outer region.) The proposed reactor, called the Molten-salt Reactor Experiment, was approved by the AEC. Design began in 1960, and construction started early in 1962. Details are given in Table C-2, and a sketch of the reactor is shown in Figure C-5.

Table C-2. MSRE parameters

Power (heat)	7.4 MW
Fuel salt	65% Li ₇ F, 29.1% BeF ₄ , 5% ZrF ₄ , 0.9 % UF ₄
Fuel melting point	813°F
Fuel inlet temperature	1,175°F
Fuel outlet temperature	1,225°F
Fuel flow rate	400 gal/min
Coolant salt	66% Li ₇ F, 34% BeF ₄
Moderator	Graphite
Container	Hastelloy-N (68% Ni, 17% Mo, 7% Cr, 5% Fe)
Critical on ²³⁵ U	June 1, 1965
Critical on ²³³ U	October 2, 1968
Shut down	December 1969

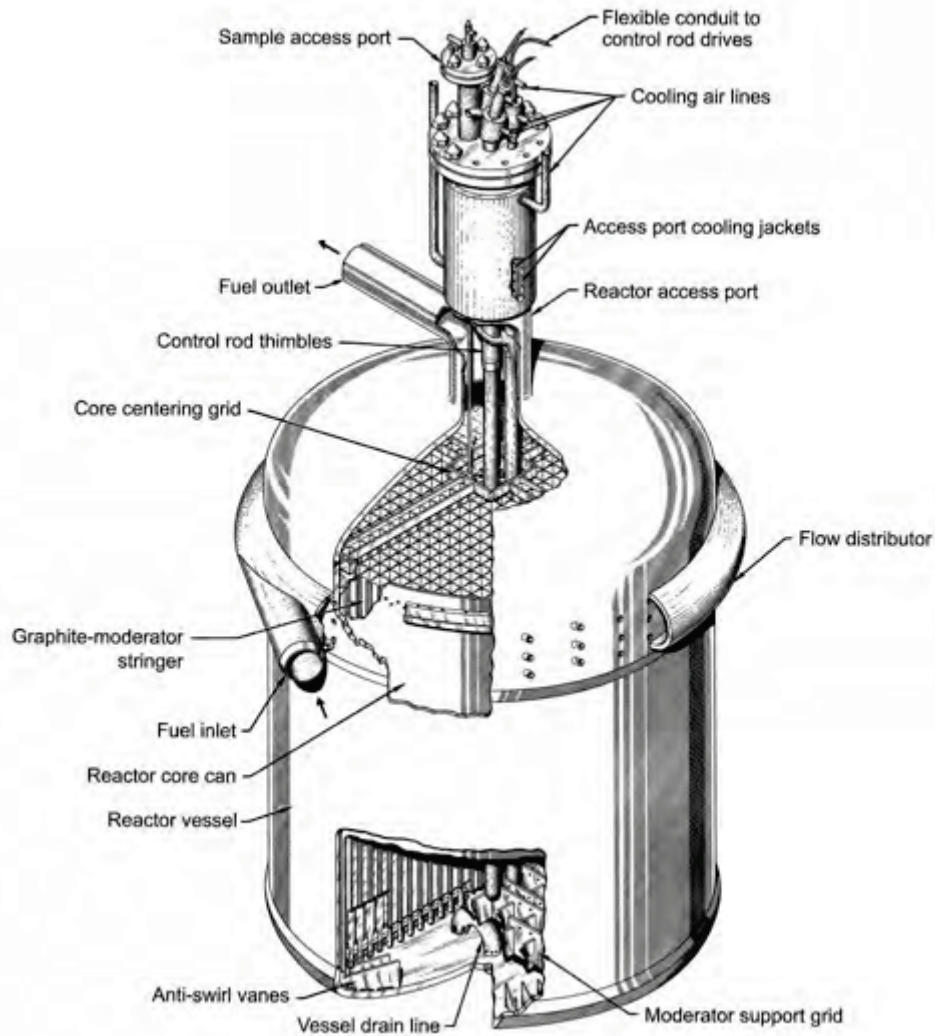

Figure C-5. Sketch of the MSRE. (ORNL-LR-DWG 61097R).

The fuel salt chosen for the MSRE was a mixture of the fluorides of lithium-7, beryllium, and zirconium selected to have good physical and nuclear properties. The melting point was 840°F. Fluoride salts do not wet graphite, so the MSRE was designed with the bare-graphite core shown in Figure C-6. It was 54 in. in diameter and made up of 2 in. square bars of specially produced low-porosity graphite. Flat passages for the salt were machined into the surfaces of the bars.



Figure C-6. Graphite core of the MSRE.

The molten salt flowed from the core to a heat exchanger where it gave up heat to another fluoride salt that carried it to an air-cooled radiator. As shown in Figure C-7, the salts were stored below the reactor in heated vessels, from which they could be forced up into the various systems by gas pressure. “Freeze valves” formed by air-cooled flattened sections of pipe retained the salts in the core. Figure C-8 is a photograph of the core, fuel pump, and heat exchanger. The radiator with its doors open is seen in operation in Figure C-9.

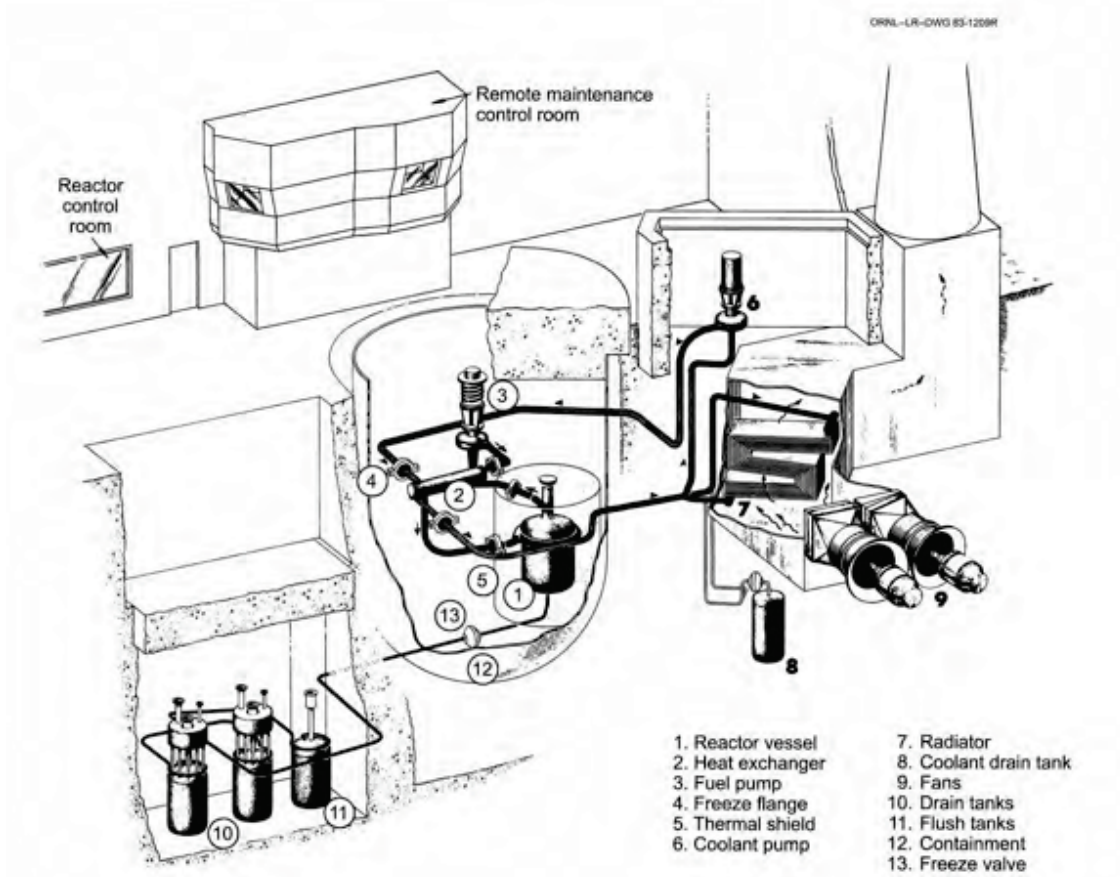

Figure C-7. Schematic of the MSRE. (ORNL-LR-DWG 63-1209R).

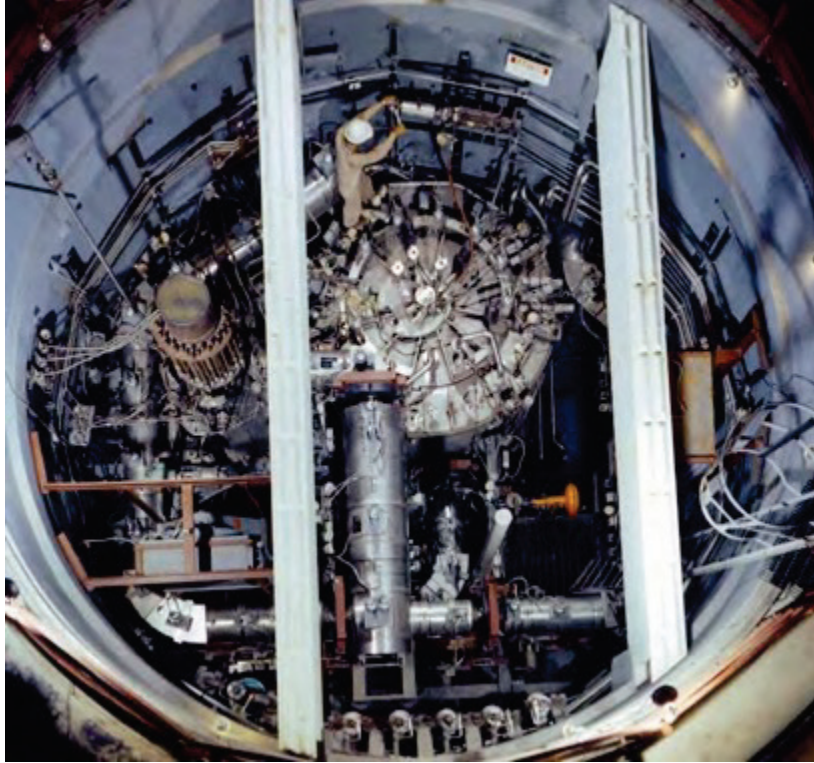

Figure C-8. MSRE core, fuel pump, and heat exchanger in the primary system containment tank.
(ORNL Photo 67051-64).

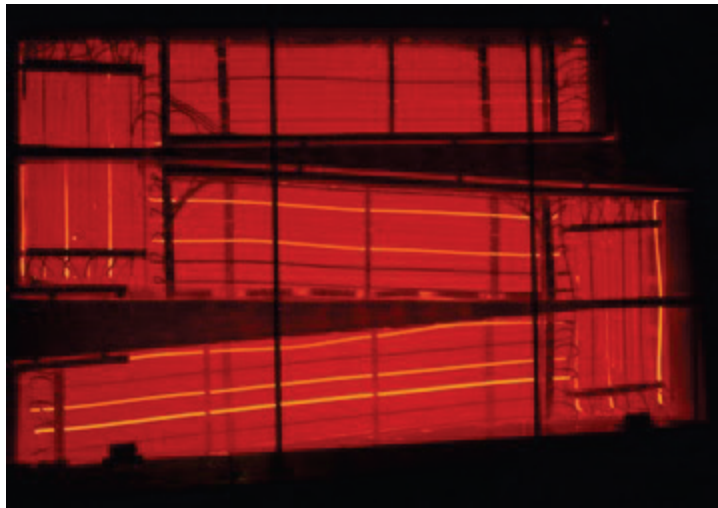

Figure C-9. MSRE air-cooled radiator with its door open.

The salt pumps were at the high points in the system and like those on the ARE, were sump type and performed several functions. The sumps served as expansion tanks and were the free surfaces for the salt systems. A spray of salt into the gas space above the sump allowed noble gases to escape and be conducted to charcoal beds. In addition, a “sampler-enricher” tube leading from above provided access to the salt in the sump. With it, capsules of frozen fuel-salt concentrate could be lowered into the sump on a cable for small fuel additions, or thimbles could

be lowered to collect salt samples.

A simple processing facility was installed in a cell near the drain tanks. It contained a tank in which salt could be sparged with hydrogen fluoride to remove water and oxygen or with fluorine to remove uranium.

The reactor and all of the components that contacted salt were made of INOR-8, a nickel-base alloy developed by ORNL and the International Nickel Company for use in molten-salt reactors. It was later commercialized as Hastelloy-N and is still in use today. All salt piping and vessels were electrically heated.

Careful provisions drawing on HRT experience were made for maintenance, in particular the design and layout of components so that they could be removed from above with long-handled tools. A 16 in. thick shield surrounding the reactor reduced activation of components by neutrons. Effective procedures were devised to control the spread of radioactivity.

Construction of the MSRE was completed in 1964, and critical experiments were run in mid-1965. To bring the reactor critical, part of the enriched uranium was added to carrier salt in the drain tank in the form of a UF₄-LiF eutectic. Then the final additions were made 88 grams at a time using the sampler-enricher.

Approach to full power began early in 1966, but within a few hours, plugs developed at several points in the fuel off-gas system. Apparently oil vapors that leaked past a gasket in the pump were polymerized by heat and radiation and deposited in small passages. Only a few grams of oil were involved, but three months was required to investigate and remedy the problem.

After full-power operation was resumed, the reactor ran well with only a few small problems until the blades in one of the main blowers that cooled the radiator broke up. Redesigned blowers were procured and installed, but other problems, including recurrences of the off-gas plugs, kept interfering with operation until mid-December when an uninterrupted run of 30 days at full power was achieved. During it the reactor was seen to be stable and load-following as a result of the strong negative temperature coefficient.

The 30-day operation was followed by progressively longer runs; one lasted for 6 months, during which the behavior of fission products was investigated. Xenon-135 poisoning was found to be well below what it would have been if all of the xenon had remained in the core. Between runs, surveillance specimens were removed from the core for examination, tests made of containment and instrumentation, and maintenance operations performed.

Even though numerous problems were encountered during the early months of power operations, they were always overcome in spite of high radiation fields, and the capability for sustained operation was demonstrated. So at the end of the 6-month run, the fuel salt was transferred to the processing tank and the uranium removed from it by treatment with fluorine. The emerging UF₆ was passed through a bed of hot sodium fluoride pellets that trapped volatile impurities, then was routed to a series of canisters in the high bay and absorbed on NaF pellets. The fuel-salt fluorination took only 47 hours, and the UF₆ that it produced was clean enough that the canisters could be handled without shielding.

Next, some U-233 that had been made in a production reactor was added to the carrier salt, making the MSRE the first reactor ever to operate on U-233. Since Glenn Seaborg, chairman of the AEC, had led the team that first created U-233, he was invited to come to Oak Ridge and start up the reactor. He is seen in Figure C-10 raising the control rod. Although U-233 has a smaller delayed-neutron fraction than U-235, the reactor was quite stable and the dynamic behavior close to predictions. Later a small amount of plutonium was added to show the fissile-fuel flexibility of molten-salt systems.



Figure C-10. Glenn Seaborg at the MSRE control panel.

The MSRE experience had increased confidence in the performance and practicality of molten-salt systems, and the Laboratory was anxious to move ahead with further development that would lead to demonstration of a breeder reactor. Since the budget was quite limited, the reactor was shut down at the end of 1969 and its funds devoted to development, particularly of a processing system that would be needed for breeding in a single-fluid reactor. Two problems that turned up during operation of the MSRE were also investigated. One was the confirmation that tritium produced in the fuel salt by neutron reactions with lithium, while small in amount, had diffused through the heat-exchanger tubes and would need to be intercepted in future reactors. The second was the discovery that although general corrosion was less than expected, fission-product tellurium had caused fine cracks on Hastelloy-N surfaces.

In spite of the technical success of the MSRE, the AEC was strongly committed to sodium-cooled fast breeder reactors and in 1973 gave orders to shut down the molten-salt program. A low-budget extension was soon granted in which solutions of the tellurium and tritium problems were demonstrated, but the program was stopped completely 2 years later. So ORNL's molten-salt adventure came to an end after 20 years.

MOLTEN-SALT REACTORS GENERAL REFERENCES

- E. S. Bettis, R. W. Schroeder, G. A. Cristy, H. W. Savage, R. G. Affel, and L. F. Hemphill. 1957. “The Aircraft Reactor Experiment—Design and Construction.” *Nuclear Science and Engineering* 2: 804–25.
- E. S. Bettis, W. B. Cottrell, E. R. Mann, J. L. Meem, and G. D. Whitman. 1957. “The Aircraft Reactor Experiment—Operation.” *Nuclear Science and Engineering* 2: 841–43.
- D. W. Cardwell, and P. N. Haubenreich. 1971. Indexed Abstracts of Selected References on Molten-Salt Reactor Technology. Rep. No. ORNL-TM-3595, Oak Ridge National Laboratory, Oak Ridge, TN.
- W. K. Ergen, A. D. Callihan, C. B. Mills, and D. Scott. 1957. “The Aircraft Reactor Experiment—Physics.” *Nuclear Science and Engineering* 2: 826–40.
- H. G. MacPherson, ed. 1958. “Part II: Molten-Salt Reactors.” In *Fluid Fuel Reactors*, 565–697. Reading, MA: Addison-Wesley, 1958.
- H. G. MacPherson. 1985. “The Molten Salt Reactor Adventure.” *Nuclear Science and Engineering* 90: 374–80.
- “Molten-Salt Reactor Experiment.” 1966. Oak Ridge National Laboratory, Oak Ridge, TN. Pamphlet.
- “A Review of Molten Salt Reactor Technology.” 1970. *Nuclear Applications and Technology* 8 (2): 102–219. Special issue comprising a set of ten papers including M. W. Rosenthal, P. R. Kasten, and R. B. Briggs, “Molten-Salt Reactors: History, Status, and Potential”; Paul N. Haubenreich and J. R. Engel, “Experience with the Molten-Salt Reactor Experiment”; and W. R. Grimes, “Molten-Salt Reactor Chemistry.”
- M. W. Rosenthal, P. N. Haubenreich, and R. B. Briggs. 1972. The Development Status of Molten-Salt Breeder Reactors. Rep. No. ORNL-4812, Oak Ridge National Laboratory, Oak Ridge, TN.
- Molten-Salt Reactor Program Semiannual Progress Report for Period Ending [August 1958–August 1976]. Rep. Nos. ORNL-2474–ORNL-5132. Oak Ridge National Laboratory, Oak Ridge, TN. <http://web.ornl.gov/info/reports/1976/3445604452553.pdf>, (last in a series of semiannual progress reports that began in 1957; they cover the MSRE and all aspects of the related R&D program.



APPENDIX B: A DEVELOPER'S PERSPECTIVE ON THE NECESSITY OF SALT PROPERTY RESEARCH

During the initial stages of the design process, it is vital to establish the capability to rapidly evaluate the base performance of different salt systems in order to select the optimal composition for a given application. This requires both extensive experimental data for the salt system in question and correlations and predictive tools that can give insight into the fundamental thermophysical salt properties for systems that have yet to be explored or have been explored only briefly.

Figure 1 outlines the salt properties data required for input to the framework of a MSR design project. Although this discussion centers on the design phase of an MSR, the same information will be required for the safety analysis. The following thermophysical properties must be known *as a function of temperature*, both in the normal operating reactor temperature range and at higher temperatures to account for criticality excursions:

- Melting point (phase diagram, and associated sensitivity with composition)
- Heat capacity
- Thermal conductivity
- Viscosity
- Density
- Vapor pressure
- Gibbs free energy of formation (and the associated redox potential)

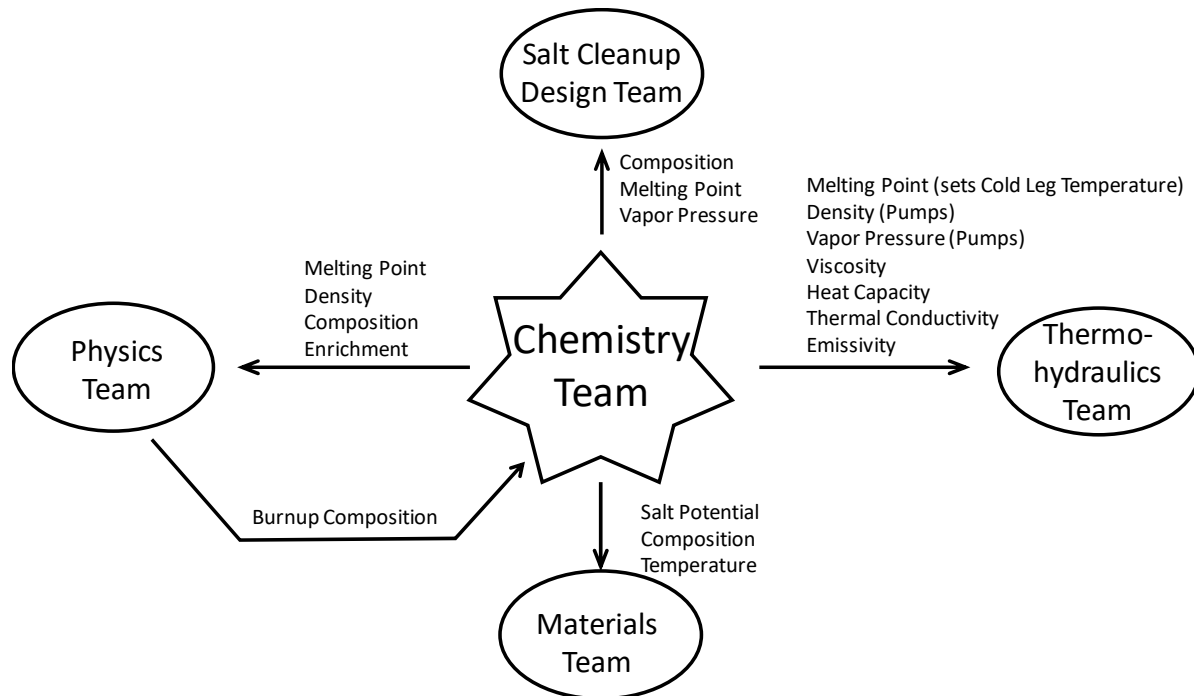

Figure 1. Organization schematic in a molten salt reactor design project.

These properties must be known for the initial salt composition (at the first startup for the reactor), as well as during reactor operation, when the salt composition will contain increasing concentrations of fission

products as a function of burnup (time and power at which the reactor operates), burnout of the fissile species (for example, $^{235}\text{U} \rightarrow 2$ fission products), and an increase in bred species (for example, $^{238}\text{U} \rightarrow ^{239}\text{Pu}$).

It will be necessary for national laboratories, universities, and industry to measure these properties where gaps exist in historically published data. It is likely that each reactor design will require its own unique data set, based upon its starting chemistry, temperature range, and burnup profile.

The following summarizes the rationale for the properties requirements for each of the reactor design groups shown in Figure 1.

Physics

This evaluation begins with neutronics, shown as “physics” in Figure 1. If a fuel salt cannot achieve and maintain criticality, it should not be explored as an option. The multiplication factor (reactivity) of any given MSR, whether using a thermal or a fast neutron spectrum, depends upon the volumetric density of fissile isotopes. This is dependent upon the composition of the salt (e.g., percent uranium halide in a halide salt mix), the enrichment of the fissile isotope (e.g., ^{235}U % within the total uranium), and the density (molar volume) of the salt mixture (where the salt is a mixture of an actinide salt and other nonfissile “carrier” salt species, e.g., NaCl, NaF, LiF, or others). The density of the salt mixture is temperature-dependent, i.e., the salt becomes less dense with increasing temperature. The resulting negative temperature-coefficient of reactivity is the basis of an MSR’s reactivity control, as well as an important passive safety feature. Reactor designers need accurate density data to accurately design the reactor size and to ensure that reactivity is adequately controlled.

The salt density of a mixture is not always an additive combination of the sum of the pure components. For some salts, the total volume of the salt mixture exceeds the sum of the individual component volumes. This molar volume anomaly is not completely understood but is thought to be due to complex ion formation and a resulting open structuring of the salt structure. This stresses the need for experimental measurements of density, since theoretical calculations are not necessarily predictive of the density of salt mixtures. Determinations of the density of the salt in and out of a reactor (with and without fission products) will be necessary to understand reactor control requirements during startup and shutdown.

Thermohydraulics

Once it has been shown that criticality can be achieved and maintained, it must then be determined that the heat transfer properties of the given system allow for heat to be effectively transported so that power may be produced. Heat exchanger design requires knowledge of salt density, heat capacity, viscosity, and thermal conductivity as a function of salt temperature and composition. Thermal radiation transport coefficients (e.g., absorption, transmission, and fluorescence) and other radiation transport effects may need to be measured and understood to predict radiative heat transport. Fluid dynamics and heat transfer properties will determine the size and geometry of the heat exchanger given a designed power output. The heat exchanger must be designed so as to prevent salt freeze-up at the outlet (cold leg) of the heat exchanger. Optimal heat exchanger designs will minimize fuel salt volume and therefore reduce the cost of the reactor.

Materials

Corrosion of reactor structural alloys is strongly affected by the electrochemical potential of the salt mixture. It is necessary to keep the reactor structural materials at sufficiently cathodic (reductive) potentials to provide thermodynamic immunity toward corrosion of structural alloys. Specific chemical effects of fission products that grow in during reactor operation and potentially attack structural alloys

need to be investigated. For example, tellurium, a fission product, was seen in the MSRE to diffuse into structural grain boundaries and produce cracks by leaching chromium from the Hastelloy N alloy. The cracking could be reduced by controlling the redox potential of the salt. Materials performance as a function of salt composition, electrochemical potential, and temperature must therefore be studied.

Auxiliary systems (cleanup)

Fission products will have to be managed at some level in all MSR designs. Off-gas hold-up and disposal systems will need to be designed for gaseous fission products. Some mechanism to remove or manage insoluble fission products will need to be in place. Some MSR designs may require a soluble fission product removal system. The composition of the fuel/burnup salt, electrochemical potentials, and vapor pressures must be known for the successful deployment of these systems.

Down-selection of candidate salts will be accomplished by each MSR design team according to its own selection criteria for salt properties. Salts with high melting points, or high neutron capture cross sections, will likely be eliminated from further consideration; and testing of other properties of these salt systems may not be useful. Fluid-fueled systems require a uranium or plutonium driver as a constituent of the primary salt—thorium can be included as a fertile constituent in some designs.

A quality control program must be instituted to guarantee the quality of the data to the level required.

Access to pure salts for laboratory studies

There is currently no supply chain for many actinide salts. Most researchers will find it necessary to synthesize their own salts using a variety of synthesis pathways. Although ORNL established processes and practices for purifying and handling fluoride salts for research and for the MSRE (J. H. Shaffer in ORNL-4616; Bamberger in *Advances in Molten Salt Chemistry 3* (1975): “Experimental techniques in molten fluoride chemistry”), there is no national standard for testing and reporting the purity of the salt. Different purification processes and procedures will be needed for other (e.g., chloride) salts. Although much, but not all, work can be done with surrogate salt systems, the properties and chemistry of the actinides will also need to be studied directly.

To enable progress in MSR salt properties research, a central repository is strongly encouraged for both actinide and surrogate salts. This would provide universities, national labs, and industry with consistent salts that would allow better cross-comparison between research groups. Site licensing controls exist for natural uranium salts, limiting the amount of uranium salt that can be stockpiled at a given research location. A central repository would allow researchers access to adequate quantities of salt, while keeping their inventories below regulatory limits. Additionally, handling plutonium salts requires extremely rigorous and specialized controls for any isotopic composition. Special consideration could be given to doing work with non-fissile plutonium as a way to avoid the nuclear safety and security burden associated with the effort. Disposal pathways must be identified as a part of any site license, and central repository disposal services would be most helpful.

Salt purification

Most salts are hygroscopic and contain significant amounts of water. Thus, best practices for dewatering salts should be studied, published, and standardized. Best practice procedures for establishing clean salt may involve some or all of the following: handling the salt in an inert atmosphere, heating the salt, and/or purging the salt with a purifying gas (e.g., HF, HCl or CCl₄), perhaps in the presence of hydrogen gas. Once a salt is purified, standard methods of handling and assaying the purity of the salt economically and routinely should be developed and standardized.

Glovebox-compatible advanced instrumentation

All handling and analysis of salts outside of closed or inert-atmosphere-blanketed containers needs to be avoided, and inert-atmosphere gloveboxes should be used. The dimensions of the analysis equipment must be such that it can be located within the volume of the glovebox. Electronics must be located outside the glovebox, since those experienced in the field are aware that standard electronics tend to fail (arcing) in the inert atmosphere. Easy operation and maintenance by the operator in gloves must be designed into the instruments.

The following characterization methods are not meant to be a complete list of candidate methods. These serve as known examples of methods currently in use or being developed for future use:

Melting point determinations

Melting points can be determined in a variety of ways, most commonly with differential scanning calorimetry (DSC). Standardization of operating parameters for DSC operation needs to be established. For example, recommendations should be made for temperature ramp rate, number of freeze/thaw cycles, purity of cover gas, purge time of the cover gas, and sample crucible material. Other melting point measurement methods may be used, and the operating parameters for these methods should be established as well.

Density and viscosity

There are a variety of methods for measuring the density and viscosity of a molten salt. The best method(s) and procedures need to be determined by the molten salt community. The Archimedes-bob Pt-method is the reference method most commonly employed for density, and various capillary and rotational methods have been used for viscosity measurement.

Electrochemical potential

Salt electrochemical potential can be calculated with quality Gibbs free energy data, which are determined from experimental thermochemical data. Electrochemical potential can also be measured directly in an electrochemical cell that uses a stable reference electrode.

If a given salt system has been shown to effectively produce and transport heat, the feasibility of the design will then rest on the safety and operational performance of the reactor system, as stated earlier.

The following are some additional questions that can inform this safety and operations evaluation:

- Do the properties of the salt change as a result of the presence of fission products, transuranics, and radiation, to the point where heat production and transport are significantly affected?
- What are the solubility limits of species that will be present over the course of operations? Is there a risk that some of these species could precipitate out in ways that would be unfavorable?
- What is the free energy of formation of the species contained in the salt in relation to the reactor's structural materials, and can it inform the extent of corrosion that will occur within the system?
- What is the vapor pressure of the species that will be present over the course of operations, to sufficiently inform considerations for liquid-gas interfaces of all systems containing a fuel salt and its byproducts?

APPENDIX C: WORKSHOP AGENDA

MOLTEN SALT CHEMISTRY WORKSHOP: Defining Technology and Applied R&D Needs for Molten Salt Chemistry

Building 5100, Joint Institute for Computational Sciences

Oak Ridge National Laboratory

Chairs: David F. Williams and Phillip F. Britt (Oak Ridge National Laboratory)

Event contact: David F. Williams, 865-574-8853 (office), 865-255-4737 (mobile); williamsdf2@ornl.gov

Monday, August 10, 2017			
Time	Event	Lead	
7:15–8:00 a.m.	ORNL Visitor Check-in and Workshop Registration at Bldg. 5100 Lobby		
8:00–8:30 a.m.	Welcome and Workshop Charge (Joint Institute for Computational Sciences [JICS] Lecture Hall) – working breakfast	Alan Icenhour, Associate Laboratory Director, Nuclear Science and Engineering Directorate, ORNL John Herczeg, Deputy Assistant Secretary, Nuclear Technology Research and Development, DOE-NE	
8:30–9:00 a.m.	Technical Working Group Perspective on Workshop	Nick Smith, MSR Technical Working Group Representative	
9:00–9:40 a.m.	Challenges in MSR Chemistry	Vic Maroni, Argonne National Laboratory Distinguished Fellow	
9:40–10:20 a.m.	Group Photo and Coffee Break	All	
10:20–11:00 a.m.	Irradiation Effects in MSR Systems	Steve Zinkle, Nuclear Engineering, University of Tennessee–Governor's Chair	
11:00–11:40 a.m.	Materials Compatibility in MSR Systems	James Keiser, Materials Science and Technology Division, ORNL	
11:40 a.m.–12:00 p.m.	Separation Options and Waste Forms	Dave Williams (ORNL)	
12:00–1:00 p.m.	Working Lunch: (JICS Lecture Hall) <ul style="list-style-type: none"> ● 12:00–12:20—serving line in Lobby <ul style="list-style-type: none"> ○ Bring lunch to Lecture Hall ● 12:30–1:00 p.m. <ul style="list-style-type: none"> ○ Working Group (WG) Charge 	Dave Williams and Phil Britt, Workshop Co-chairs (ORNL)	
1:00–5:30 p.m.	Parallel Working Group Sessions <ul style="list-style-type: none"> ● WG#1: Physical Chemistry and Salt Properties ● WG#2: Analytical Chemistry (includes measurement instruments and online sensors) ● WG#3: Molten Salt Fission Product Chemistry and Solid Salt Radiolysis ● WG#4: Materials Compatibility ● WG#5: Computational Chemistry and Materials Science 	WG Co-Chairs <ul style="list-style-type: none"> WG#1: Alex Navrotsky, Mark Williamson WG#2: Sam Bryan, Sheng Dai WG#3: Bill DeCul, Tina Nenoff WG#4: James Keiser, Preet Singh WG#5: Bobby Sumpter, Brian Wirth 	Locations <ol style="list-style-type: none"> 1. Rm 130 2. Rm 262 (Boardroom) 3. Rm 128 (Lecture Hall) 4. Bldg 5700, Rm E104* (Monday only) 5. Rooms among all groups

Monday, August 10, 2017 (continued)														
Time	Event	Lead												
5:45–7:00 p.m.	Onsite Working Dinner – WG Status	Dinner for All, WG status from chairs (JICS Lobby)												
7:00–9:00 p.m.	Parallel Working Group Sessions (cont.)	WG Members led by chairs / designated location above												
9:00 p.m.	Adjourn Day 1	All												
Tuesday, August 11, 2017														
Time	Event	Lead												
8:00–10:15 a.m.	Working Group Sessions – Working Breakfast <i>Breakfast served in JICS Lobby</i> <ul style="list-style-type: none"> ● WG#1: Physical Chemistry and Salt Properties ● WG#2: Analytical Chemistry ● WG#3: Molten Salt Fission Product Chemistry and Solid Salt Radiolysis ● WG#4: Materials Compatibility ● WG#5: Computational Chemistry and Materials Science 	<table border="0"> <tr> <td style="text-align: center;">WG Co-Chairs</td> <td style="text-align: center;">Locations</td> </tr> <tr> <td>WG#1: Alex Navrotsky, Mark Williamson</td> <td>1. Rm 130</td> </tr> <tr> <td>WG#2: Sam Bryan, Sheng Dai</td> <td>2. Rm 262 (Boardroom)</td> </tr> <tr> <td>WG#3: Bill DelCul, Tina Nenoff</td> <td>3. Rm 128 (Lecture Hall)</td> </tr> <tr> <td>WG#4: James Keiser, Preet Singh</td> <td>4. Rm 134 (Learning room)</td> </tr> <tr> <td>WG#5: Bobby Sumpter, Brian Wirth</td> <td>5. Bldg. 4100, Rm 203</td> </tr> </table>	WG Co-Chairs	Locations	WG#1: Alex Navrotsky, Mark Williamson	1. Rm 130	WG#2: Sam Bryan, Sheng Dai	2. Rm 262 (Boardroom)	WG#3: Bill DelCul, Tina Nenoff	3. Rm 128 (Lecture Hall)	WG#4: James Keiser, Preet Singh	4. Rm 134 (Learning room)	WG#5: Bobby Sumpter, Brian Wirth	5. Bldg. 4100, Rm 203
WG Co-Chairs	Locations													
WG#1: Alex Navrotsky, Mark Williamson	1. Rm 130													
WG#2: Sam Bryan, Sheng Dai	2. Rm 262 (Boardroom)													
WG#3: Bill DelCul, Tina Nenoff	3. Rm 128 (Lecture Hall)													
WG#4: James Keiser, Preet Singh	4. Rm 134 (Learning room)													
WG#5: Bobby Sumpter, Brian Wirth	5. Bldg. 4100, Rm 203													
10:15–10:40 a.m.	Break and Reconvene in JICS Auditorium	All												
10:40–11:00 a.m.	Report <ul style="list-style-type: none"> ● WG#1: Physical Chemistry, Salt Properties 	WG#1: Alex Navrotsky, Mark Williamson												
11:00–11:20 a.m.	Report <ul style="list-style-type: none"> ● WG#2: Analytical Chemistry 	WG#2: Sam Bryan, Sheng Dai												
11:20–11:40 a.m.	Report <ul style="list-style-type: none"> ● WG#3: Molten Salt Fission Product Chemistry and Solid Salt Radiolysis 	WG#3: Bill DelCul, Tina Nenoff												
11:40 a.m.–12:00 p.m.	Report <ul style="list-style-type: none"> ● WG#4: Materials Compatibility 	WG#4: James Keiser, Preet Singh												
12:00–1:00 p.m.	Working Lunch – Report <i>(Serving line in JICS Lobby, return to Lecture Hall)</i> <ul style="list-style-type: none"> ● WG#5: Computational Chemistry and Materials Science 	WG#5: Bobby Sumpter, Brian Wirth												
1:00–5:30 p.m.	WG Sessions (cont.)	WG members/designated location as above												
5:30–6:30 p.m.	Onsite Working Dinner – WG Status	Dinner for all, WG chair status (JICS Lobby)												
6:30–9:00 p.m.	WG Preparation for Final Workshop Plenary	All												
9:00 p.m.	Adjourn Day 2	All												

Wednesday, August 12, 2017		
Time	Event	Lead
8:00–8:30 a.m.	Report <ul style="list-style-type: none"> WG#1: Physical Chemistry, Salt Properties 	WG#1: Alex Navrotsky, Mark Williamson
8:30–9:00 a.m.	Report <ul style="list-style-type: none"> WG#2: Analytical Chemistry 	WG#2: Sam Bryan, Sheng Dai
9:00–9:30 a.m.	Report <ul style="list-style-type: none"> WG#3: Molten Salt Fission Product Chemistry and Solid Salt Radiolysis 	WG#3: Bill DeCul, Tina Nenoff
9:30–10:00 a.m.	Report <ul style="list-style-type: none"> WG#4: Materials Compatibility 	WG#4: James Keiser, Preet Singh
10:00–10:30 a.m.	Break	All
10:30–11:00 a.m.	Report and Discussion <ul style="list-style-type: none"> WG#5: Computational Chemistry and Materials Science 	WG#5: Bobby Sumpter, Brian Wirth
11:00–11:30 a.m.	Final Discussion and Closing Remarks	John Herczeg, DOE-NE Dave Williams, ORNL
11:30 a.m.	Adjourn Day 3*	All
Report Team Agenda (same as previous breakout rooms)		
1:30–5:00 p.m.	Writing Team	Tuesday Breakout Rooms

*You are welcome to lunch at the ORNL Cafeteria on Wednesday. A workshop lunch is not provided on Wednesday.

APPENDIX D: WORKSHOP PARTICIPANTS



Registered participants for April 10–12, 2017, Molten Salt Chemistry Workshop at ORNL

Name	Organization	Role
Abney, Carter	Oak Ridge National Laboratory	Analytical Chemistry (scribe)
Besmann, Ted	University of South Carolina	Computational Chemistry/Materials
Betzler, Ben	Oak Ridge National Laboratory	Computational Chemistry/Materials (scribe)
Bresee, James	Department of Energy, Office of Nuclear Energy	Observer
Britt, Phil	Oak Ridge National Laboratory	Meeting co-chair
Bryan, Sam	Pacific Northwest National Laboratory	Analytical Chemistry
Calderoni, Pattrick	Idaho National Laboratory	Analytical Chemistry
Chidambaram, Dev	University of Nevada, Reno	Materials Compatibility
Chvala, Ondrej	University of Tennessee	Computational Chemistry/Materials
Cooper, Thurman	Terrestrial Energy USA Ltd	Physical Chemistry and Salt Properties

Name	Organization	Role
Czerwinski, Ken	TerraPower	Physical Chemistry and Salt Properties
Dai, Sheng	Oak Ridge National Laboratory	Analytical Chemistry (WG co-chair)
DelCul, Bill	Oak Ridge National Laboratory	Molten Salt Fission Product Chemistry (WG co-chair)
Dingreville, Remi	Sandia National Laboratories	Computational Chemistry/Materials
Dixon, David	The University of Alabama	Computational Chemistry/Materials
Dunstan, Don	Energy Storage Solutions	Materials Compatibility
Fredrickson, Guy	Idaho National Laboratory	Molten Salt Fission Product Chemistry
Hammelmann, James	US Nuclear Regulatory Commission	Observer
Hanson, Michael	Elysium Industries	Physical Chemistry and Salt Properties
Henager, Charles	Pacific Northwest National Laboratory	Computational Chemistry/Materials (WG co-chair)
Herczeg, John	Department of Energy, Office of Nuclear Energy	Speaker/Observer
Horton, Linda	Department of Energy, Basic Energy Sciences	Observer
Icenhour, Alan	Oak Ridge National Laboratory	Speaker/Observer
Keiser, James	Oak Ridge National Laboratory	Speaker/ Materials Compatibility (WG co-chair)
Kim, Hojong	The Pennsylvania State University	Molten Salt Fission Product Chemistry
Kruizenga, Alan	Sandia National Laboratories	Materials Compatibility
Kung, Stephen	Department of Energy, Office of Nuclear Energy	Observer
Longford, Des	PHDS Co.	Analytical Chemistry
Margulis, Claudio	University of Iowa	Computational Chemistry/Materials
Maroni, Vic	Argonne National Laboratory	Speaker/Physical Chemistry and Salt Properties (scribe)
Marsden, Kenneth	Idaho National Laboratory	Molten Salt Fission Product Chemistry
Massie, Mark	Transatomic Power Corporation	Observer/ Industry Representative
Mayes, Richard	Oak Ridge National Laboratory	Molten Salt Fission Product Chemistry (scribe)
Mays, Gary	Oak Ridge National Laboratory	Physical Chemistry and Salt Properties
McDuffee, Joel	Oak Ridge National Laboratory	Molten Salt Fission Product Chemistry
McLaughlin, David	Westinghouse Electric Co. Ltd	Physical Chemistry and Salt Properties
McNeese, James	Lawrence Livermore National Laboratory	Molten Salt Fission Product Chemistry
Meeks, Noah	Southern Company Services	Observer/ Industry Representative
Memcott, Matthew	Brigham Young University	Physical Chemistry and Salt Properties
Motsegood, Perry	Argonne National Laboratory	Analytical Chemistry
Muralidharan, Govindarajan	Oak Ridge National Laboratory	Materials Compatibility
Navrotsky, Alexandra	University of California–Davis	Physical Chemistry and Salt Properties (WG co-chair)

Name	Organization	Role
Nenoff, Tina	Sandia National Laboratories	Molten Salt Fission Product Chemistry (WG co-chair)
Pal, Uday	Boston University	Physical Chemistry and Salt Properties
Pheil, Ed	Elysium Industries	Physical Chemistry and Salt Properties
Qualls, Lou	Oak Ridge National Laboratory	Observer
Raiman, Stephen	Oak Ridge National Laboratory	Materials Compatibility (scribe)
Rappleye, Devin	Lawrence Livermore National Laboratory	Analytical Chemistry
Robertson, Sean	Transatomic Power Corporation	Observer/ Industry Representative
Rohatgi, Upendra	Brookhaven National Laboratory	Observer
Salay, Michael	US Nuclear Regulatory Commission	Observer
Scarlat, Raluca	University of Wisconsin	Physical Chemistry and Salt Properties
Shaka, A. J.	University of California-Irvine	Analytical Chemistry
Sham, Sam	Argonne National Laboratory	Materials Compatibility
Singh, Preet	Georgia Institute of Technology	Materials Compatibility (WG co-chair)
Smith, Nicholas	Southern Company Services	Speaker/ Materials Compatibility
Sorensen, Kirk	Flibe Energy	Physical Chemistry and Salt Properties
Stoddard, Michael	Alpha Tech Research Corp	Molten Salt Fission Product Chemistry
Sumpter, Bobby	Oak Ridge National Laboratory	Computational Chemistry/Materials (WG co-chair)
Sun, Xaidong	University of Michigan	Materials Compatibility
Terrani, Kurt	Oak Ridge National Laboratory	Materials Compatibility
Todd, Terry	Idaho National Laboratory	Molten Salt Fission Product Chemistry
Tortorelli, Peter	Oak Ridge National Laboratory (retired)	Materials Compatibility
Wells, Daniel	Electric Power Research Institute	Physical Chemistry and Salt Properties
Williams Dave	Oak Ridge National Laboratory	Meeting co-chair
Williams, Joseph	US Nuclear Regulatory Commission	Observer
Williamson, Mark	Argonne National Laboratory	Physical Chemistry and Salt Properties (WG co-chair)
Willit, James	Argonne National Laboratory	Molten Salt Fission Product Chemistry
Wilson, Dane	ThorCon Power	Materials Compatibility
Wirth, Brian	University of Tennessee	Computational Chemistry/Materials (WG co-chair)
Zinkle, Steve	University of Tennessee	Speaker/Materials Compatibility
Ziock, Klaus	Oak Ridge National Laboratory	Molten Salt Fission Product Chemistry

This report was prepared as an account of work sponsored by an agency of the United States Government. Neither the United States Government nor any agency thereof, not any of their employees, makes any warranty, express or implied, or assumes any legal liability or responsibility for the accuracy, completeness, or usefulness of any information, apparatus, product, or process disclosed, or represents that its use would not infringe privately owned rights. Reference herein to any specific commercial product, process, or service by trade name, trademark, manufacturer, or otherwise, does not necessarily constitute or imply its endorsement, recommendation, or favoring by the United States government or any agency thereof. The views and opinions of authors expressed herein do not necessarily state or reflect those of the United States Government or any agency thereof.